

RADIO CRAFT



**RADIO ROBOT
FLAMETANKS**

SEE PAGE 766

ALEX
SCHÖNBURG

SEPT.

1945

25¢

CANADA 30¢

RADIO-ELECTRONICS IN ALL ITS PHASES

CONSOLIDATED VULTEE USES **RAYTHEON** TUBES

in Electronic Recorder for Flight Testing

No more tedious pencil notations . . . no more bulky camera equipment! An amazing "electric brain" developed by Consolidated Vultee Aircraft Corporation now helps this firm test its new planes *electronically*.

This remarkable device, consisting of a transmission unit in the plane and a receiving-recording station on the ground, employs a large number of famous Raytheon High-Fidelity Tubes.

It's just one of thousands of examples that prove an important point: *where dependable performance is vital, you will find Raytheon Tubes*. That means Raytheon Tubes can be relied upon to help you do your best service work and thus build your business steadily.

Switch to Raytheon Tubes *now* . . . and watch for a revolutionary merchandising program that Raytheon is developing for your benefit!

Increased turnover and profits, plus easier stock control, are benefits which you may enjoy as a result of the Raytheon standardized tube type program, which is part of our continued planning for the future.

Raytheon Manufacturing Company

RADIO RECEIVING
TUBE DIVISION
Newton, Mass. • Los Angeles
New York
Chicago • Atlanta

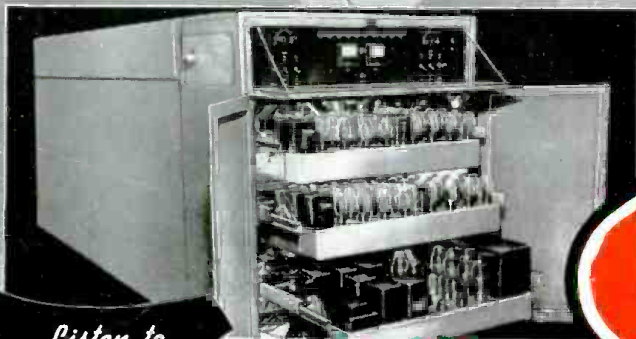

Listen to
"MEET YOUR NAVY"
AMERICAN BROADCASTING CO.
Every Monday Night
Coast to Coast
181 Stations

ALL FOUR DIVISIONS HAVE BEEN
AWARDED ARMY-NAVY "E" WITH STARS

Devoted to Research and the Manufacture of Tubes for the New Era of Electronics





J. E. SMITH, PRESIDENT
National Radio Institute
31st Year of Training Men
for Success in Radio

I will send you a Lesson FREE to show how I train you at home in spare time for **GOOD JOBS in RADIO**

I Trained These Men



\$50 a Week From Own Shop
"Am making over \$50 a week profit from my own shop. Have another N.R.I. graduate working for me. I like to hire N.R.I. men because they know radio."
— **NORMAN MILLER**,
Hebron, Neb.

Chief Engineer,
Station KWLM

"Am now Chief Engineer of Station KWLM and in charge of maintenance of Police Station KLIN, County Highway Dept. Also have my own business. Mighty glad to be in radio."
— **LLOYD V. STENBERG**, 516 Litchfield Ave., W. Willmar, Minn.



\$600 a Year in Spare Time
"At present I am doing spare time radio work. I earned money in radio before graduating. My profits for the last twelve months were \$600."
— **ERWIN F. BOETTCHER**,
Marinette, Wisconsin.

I want to give every man who's interested in Radio, either professionally or as a hobby, a copy of my Lesson, "Getting Acquainted with Receiver Servicing" — absolutely **FREE!** It's a valuable lesson. Study it—keep it—use it—without obligation! And with it I'll send my 64-page, illustrated book, "Win Rich Rewards in Radio," **FREE.** It describes many fascinating jobs in Radio, tells how N. R. I. trains you at home in spare time, how you get practical experience with **SIX KITS OF RADIO PARTS I send.**

The "Sample" Lesson will show you why the easy-to-grasp lessons of the N. R. I. Course have paved the way to good pay for hundreds of other men. I will send it to you without obligation. **MAIL THE COUPON!**

Good Future for Trained Men in Radio, Television, Electronics

The Radio Repair business is booming **NOW.** There is good money fixing Ra-

dios in your spare time or own full time business. And trained Radio Technicians also find wide-open opportunities in Police, Aviation and Marine Radio, in Broadcasting, Radio Manufacturing, Public Address work, etc. Also, there are good jobs operating, maintaining and installing Radio equipment used in schools, hotels, factories, churches, hospitals, offices, theatres, trains. Send for **FREE** book which pictures your opportunities.

Think of the boom coming when new Radios can be made! Think of the backlog of business built up in all branches of Radio! And think of even greater opportunities when Television, FM, Electronics, can be offered to the public! Use only a few hours of your spare time each week to get into Radio **NOW.** You may never again see the time when it will be so easy and profitable to get started. Mail coupon for complete information.

Many Beginners Soon Make \$5, \$10 a Week EXTRA in Spare Time

The day you enroll I start sending **EXTRA MONEY JOB SHEETS** to help you make **EXTRA** money fixing Radios in spare time while learning. You **LEARN** Radio principles from my easy-to-grasp Lessons—**PRACTICE** what you learn by building real Radio Circuits with the six kits of Radio parts I send—**USE** your knowledge to make **EXTRA** money while getting ready for a good full time Radio job.

Mail Coupon for FREE Lesson and Book

MAIL THE COUPON for your **SAMPLE LESSON** and **FREE 64-page book.** See how practical it is to train at home in your spare time. Read the details about my Course. See the fascinating jobs Radio offers. Read letters from men I trained, telling what they are doing, earning. No obligation. Just **MAIL COUPON** in an envelope or paste it on a penny postal. **J. E. SMITH, President, Dept. 5JX National Radio Institute, Pioneer Home Study Radio School, Washington 9, D. C.**

**TELEVISION
ELECTRONICS
FREQUENCY
MODULATION**

My up-to-date Course includes training in these new developments.

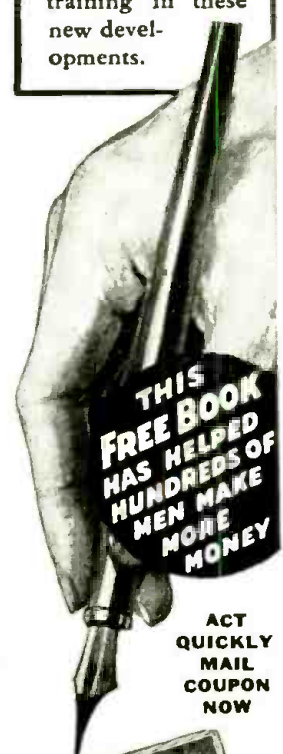

ACT QUICKLY MAIL COUPON NOW

You Build These and Many Other Radio Circuits with Kits I Supply

By the time you've conducted 60 sets of Experiments with Radio Parts I supply—have made hundreds of measurements and adjustments—you'll have had valuable **PRACTICAL** experience.

You build this **SUPERHETERODYNE CIRCUIT** containing a pre-selector, oscillator—mixer—first detector, i.f. stage, diode detector—a.v.c. stage and audio stage. It will bring in local and distant stations. Get the thrill of learning at home evenings in spare time while you put the set through fascinating tests!

Building this **A. M. SIGNAL GENERATOR** will give you valuable experience. Provides amplitude-modulated signals for test and experimental purposes.

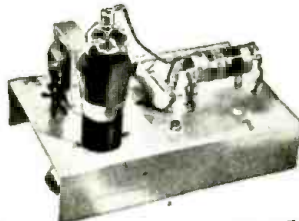
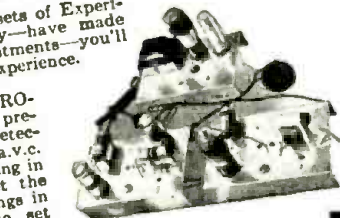
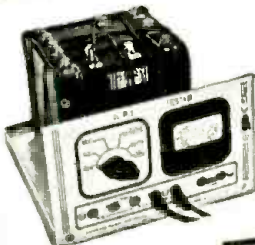

You build this **MEASURING INSTRUMENT** early in Course. Useful for work on Radios to make spare time money. It is a vacuum tube multimeter, measures A.C., D.C., R.F. volts, D.C. currents, resistance, receiver output.

GET BOTH 64 PAGE BOOK **FREE** SAMPLE LESSON

J. E. SMITH, President, Dept. 5JX NATIONAL RADIO INSTITUTE, Washington 9, D. C.

Without obligating me, mail your Sample Lesson and 64-page Book **FREE.** I am particularly interested in the branch of Radio checked below. (No salesman will call. Please write plainly.)

- .. Radio Service Business of My Own Technician for Radio Stores
- .. Spare Time Radio Servicing
- .. Gov't. Civilian Radio Job Aviation Radio
- .. Operating Broadcasting Stations
- .. Army, Navy Radio
- .. Operating Police Radio Stations
- .. Operating Ship and Harbor Radio

(If you have not decided which branch you prefer—mail coupon for facts to help you decide.)

Name Age
Address
City State 4FR
(Please include Post Office Zone Number)





**THE "FLYING UTE"
CUTS 3 HOURS
FROM AVERAGE
RUNNING TIME**



DENVER, COLO.— Using Motorola Radio 118 Mgc. equipment for vocal communications between locomotive and caboose, the "Flying Ute," crack freight of the Denver and Rio Grande Western, cut three hours off the average running time between Denver and Salt Lake City, it was announced today after a trial run.

with *Motorola*
**F-M 2-WAY RADIO-
TELEPHONE SYSTEM**

The efficiency, economy and safety provided by Motorola F-M two-way radiotelephone were demonstrated again—with spectacular results! On a test run over the rugged, mountainous route between Denver and Salt Lake City, "The Flying Ute," fast Diesel freight, carried 65 cars of explosives and other vital war materials.

The 570 mile run included 50 tunnels, but clear and intelligible communications between engine and caboose were maintained throughout most of the route.

FREE! Write for detailed Motorola Radiotelephone Directory covering more than 1000 Motorola two and three way F-M systems now operating in United States, Canal Zone and Hawaii.



GALVIN MFG. CORPORATION • CHICAGO 51

F-M & A-M HOME RADIO • AUTO RADIO • AUTOMATIC PHONOGRAPHS • TELEVISION • F-M POLICE RADIO • RADAR • MILITARY RADIO

I'LL SHOW YOU HOW TO SUCCEED IN RADIO

Here's the right training for Big Post-War Pay!



F. L. Sprayberry, one of the country's foremost Radio Teachers.



A RADIO SERVICE BUSINESS OF YOUR OWN



A GOOD JOB IN RADIO & TELEVISION BROADCASTING



RADIO-ELECTRONIC SERVICE ENGINEER

BE A RADIO-ELECTRONICIAN



I SUPPLY A FULL RADIO SET for practical easy LEARNING

NOW! YOU CAN PREPARE AT HOME IN YOUR SPARE TIME FOR THE AMAZING OPPORTUNITIES AHEAD IN RADIO — ELECTRONICS — TELEVISION

The offer I make you here is the opportunity of a lifetime. It's your big chance to get ready for a wonderful future in the swiftly expanding field of Radio-Electronics INCLUDING Radio, Television, Frequency Modulation and Industrial Electronics. Be wise! NOW'S the time to start. Opportunities ahead are tremendous! No previous experience is necessary. The Sprayberry Course starts right at the beginning of Radio. You can't get lost. It gets the various subjects across in such a clear, simple way that you understand and remember. And, you can master my entire course

in your spare time. It will not interfere in any way with your present duties. Along with your Training, you will receive my famous BUSINESS BUILDERS which will show you how to make some nice profits while learning.

Prepares You for a Business of Your Own or Good Radio Job

My training will give you the broad, fundamental principles so necessary as a background, no matter which branch of Radio you wish to specialize in. I make it easy for you to learn Radio Set Repair and Installation Work. I teach you how to install and repair Electronic Equipment. In fact, you'll be a fully qualified RADIO-ELECTRONICIAN, equipped with the skill and knowledge to perform efficiently and to make a wonderful success of yourself.

Just Out! FREE!

"How to Read Radio Diagrams & Symbols" a valuable new book which explains in simple English how to read and understand any Radio Set Diagram. Provides the quick key to analyzing any Radio circuit. Includes translations of all Radio symbols. Send for this FREE book now, and along with it I will send you another big FREE book describing my Radio-Electronic training.



GET FREE BOOKS

SPRAYBERRY TRAINING GIVES YOU BOTH TECHNICAL KNOWLEDGE SKILLED HANDS

There's only one right way to learn Radio Electronics. You must get it through simplified lesson study combined with actual "shop" practice under the personal guidance of a qualified Radio Teacher. It's exactly this way that Sprayberry trains you . . . supplying real Radio parts for learn-by-doing experience right at home. Thus, you learn faster, your understanding is clear-cut, you acquire the practical "know how" essential to a good-paying Radio job or a Radio business of your own.

I'll Show You a New, Fast Way to Test Radio Sets Without Mfg. Equipment
The very same Radio Parts I supply with your Course for gaining pre-experience in Radio Repair work may be adapted through an exclusive Sprayberry wiring procedure to serve for complete, fast, accurate Radio Receiver troubleshooting. Thus, under Sprayberry meth-

ods, you do not have one cent of outlay for manufactured Test Equipment which is not only expensive but scarce.

Read What Graduate Says "One Job Nets About \$26.00"

"Since last week I fixed 7 radios, all good-paying jobs and right now I am working on an amplifier system. This job alone will net me about \$26.00. As long as my work keeps coming in this way, I have only one word to say and that is, 'Thanks to my Sprayberry training' and I am not afraid to boast about it."—ADRIEN BENJAMIN, North Grovenordale, Conn.

DON'T PUT IT OFF!

Get the facts about my training—now! Take the first important step toward the money-making future of your dreams. All features are fully explained in my big, illustrated FREE Catalog which comes to you along with another valuable FREE book you'll be glad to own. Mail Coupon AT ONCE!

RADIO CRAFT

AND POPULAR ELECTRONICS

Incorporating
SHORT WAVE CRAFT TELEVISION NEWS
RADIO & TELEVISION



HUGO GERNSBACK, *Editor-in-Chief*
FRED SHUNAMAN, *Associate Editor*
I. QUEEN, *Editorial Associate*
ELMER FULLER, *Shortwave Editor*
E. A. WITTEN, *Technical Editor*
A. PASCALE, *Production Manager*
G. ALIQUO, *Circulation Manager*
JOHN J. LAMSON, *Advertising Director*
ALFRED STERN, *Promotion Manager*

IN THE NEXT ISSUE

UHF Antennas and Waveguides
Ten Test Instruments in One
Hold-in-Hand Signal Tracer
Servicing the Output Stage

Published by Radercraft Publications, Inc.
Publication Office: 29 Worthington Street, Springfield 3, Mass.
Editorial and Advertising Offices: 25 West Broadway, Tel. RE2-9690, New York 7, N. Y.
Chicago Advertising Office: Radio-Craft, 308 W. Washington Street, Suite 1413, Chicago 6, Ill. Tel. Randolph 7363.
Cleveland Advertising Office: 405 Erie Bldg., Cleveland, Ohio. Burdette Phillips, Manager. Tel. Main 9645.
Los Angeles Advertising Office: 606 South Hill Street, Los Angeles 14, Calif. Ralph W. Harker, Manager.
San Francisco Advertising Office: 582 Market St., San Francisco 4, Calif. Ralph W. Harker, Manager. Tel. Garfield 2481.
New England Office: Bridgewater, Conn., W. D. Ward, Manager.
RADIO-CRAFT is published monthly on the 25th of the month preceding that of date. Subscription rates: United States and possessions, Mexico, Central and South American countries, \$2.50 a year, \$4.00 for two years, \$6.00 for three years. Canada, \$3.00 a year, \$5.00 for two years, \$7.50 for three years. All other foreign countries, \$3.25 a year, \$5.50 for two years, \$8.25 for three years. Special rates for members of the Armed Forces in U. S., or those addressed by A.P.O. or F.P.O. mail, \$2.00. Entered at the post office at Springfield as second-class matter under the Act of March 3, 1879. All communications about subscriptions should be addressed to: Circulation Manager, Radio-Craft, 29 Worthington St., Springfield 3, Mass.

Notice of CHANGE of ADDRESS should reach us at least one month in advance. When ordering a change, please furnish an address stencil impression from a recent wrapper if you can. Address changes cannot be made without the old address as well as the new.

Foreign Agents

London—Atlas Publishing and Distributing Co., Ltd., 18 Bride Lane, Fleet St., London, E.C. 4.
Melbourne—McGill's Agency, 179 Elizabeth St., Australia.

Text and illustrations of this magazine are copyright and must not be reproduced without permission of the copyright owners.
Copyright, 1945, Radercraft Publications, Inc.

Contents September 1945 Volume XVI, No. 12

Editorial: The New Radio Receivers.....	by Hugo Gernsback	761
Radio-Electronics Monthly Review.....		762
Beware! The Serviceman!.....	by E. A. Witten	774

ELECTRONICS

Dynamic Phono Pickup.....	by J. M. Lee	764
A Decibel Nomograph.....	by Nathaniel Rhita	769

WAR-TIME RADIO

Radio Robot Flame Tanks (Cover Story).....	by Hugo Gernsback	766
--	-------------------	-----

RADIO TRAINING

Making Wartime Engineers.....	by Dr. K. R. Sturley	768
Broadcast Equipment, Part XI.....	by Don C. Hoefler	775
Detector Circuits, Part II.....	by Robert F. Scott	776
Negative Feedback.....	by John W. Straede	777

SERVICING

Accounting in the Radio Shop.....	by Gene Conklin	767
Radios Serviced by Observation.....	by Lyle Treagle	770
Tube Replacements, Part III.....	by I. Queen	772
Substitute for 35Z5's.....	by Gerry L. Gaydo	803

CONSTRUCTION

"Loud" Crystal Radio.....	by Joseph Dante Amorose	782
A Startling Superhet.....	by W. T. Connatser	783
Superhet Coil Design.....	by Sgt. Lionel R. Blattner	789
Intercommunicator.....	by E. J. Thompson	791
Chassis Cradle from Pipe Fittings.....	by William Lyon	801

TEST INSTRUMENTS

Adapter for the V.T.V.M.....	by Alfred Shortcut	773
Simple Multitester for Volts and Ohms.....	by Homer L. Davidson	778
Tracer With Triode Probe.....	by D. T. Moore	802
Transconductance Tester.....	by Hyman Herman	804

DEPARTMENTS

World-Wide Station List.....	by Elmer R. Fuller	784
New Radio-Electronic Devices.....		786
Radio-Electronic Circuits.....		788
Try This One!.....		790
Question Box.....		792
Progress in Invention.....	by I. Queen	794
Technotes.....		805
Available Radio-Electronic Literature.....		798
Communications.....		812
Book Reviews.....		815
Why Not?.....		816



ON THE COVER

A raid by automatic flame-throwing tanks somewhere on the islands of Japan is the subject of our cover this month. The tanks have antennas at the rear—mounted in corner reflectors—and are operated by soldiers with push-button transmitters very much like the familiar Handie- or Walkie-Talkies.

over and above all . . .

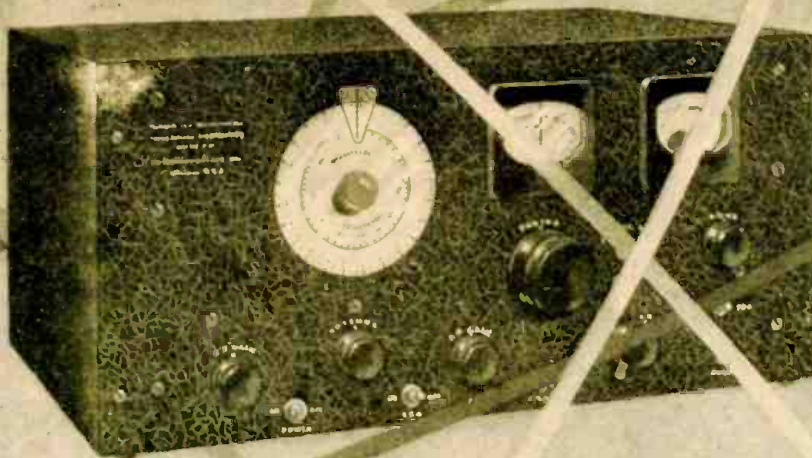

For very high frequency work . . .

Hallicrafters S-37 stands over and above all. Providing both AM and FM reception on all frequencies from 130 to 210 Mc., it covers a higher range than is available in any other commercially built receiver. The development is typical of the ingenuity and resourcefulness that Hallicrafters bring to the ever-new problems in electronics and communications. Forward looking technicians in these fields must look to Hallicrafters for instruments that will chart the new directions.

Model S-37 . . . The highest frequency range of any continuous tuning commercial type receiver.

(COPYRIGHT 1945 THE HALLCRAFTERS CO.)



Buy a War



Bond Today!

hallicrafters RADIO

THE HALLCRAFTERS CO., MANUFACTURERS OF RADIO AND ELECTRONIC EQUIPMENT • CHICAGO 16, U. S. A.

RADIO-CRAFT for SEPTEMBER, 1945

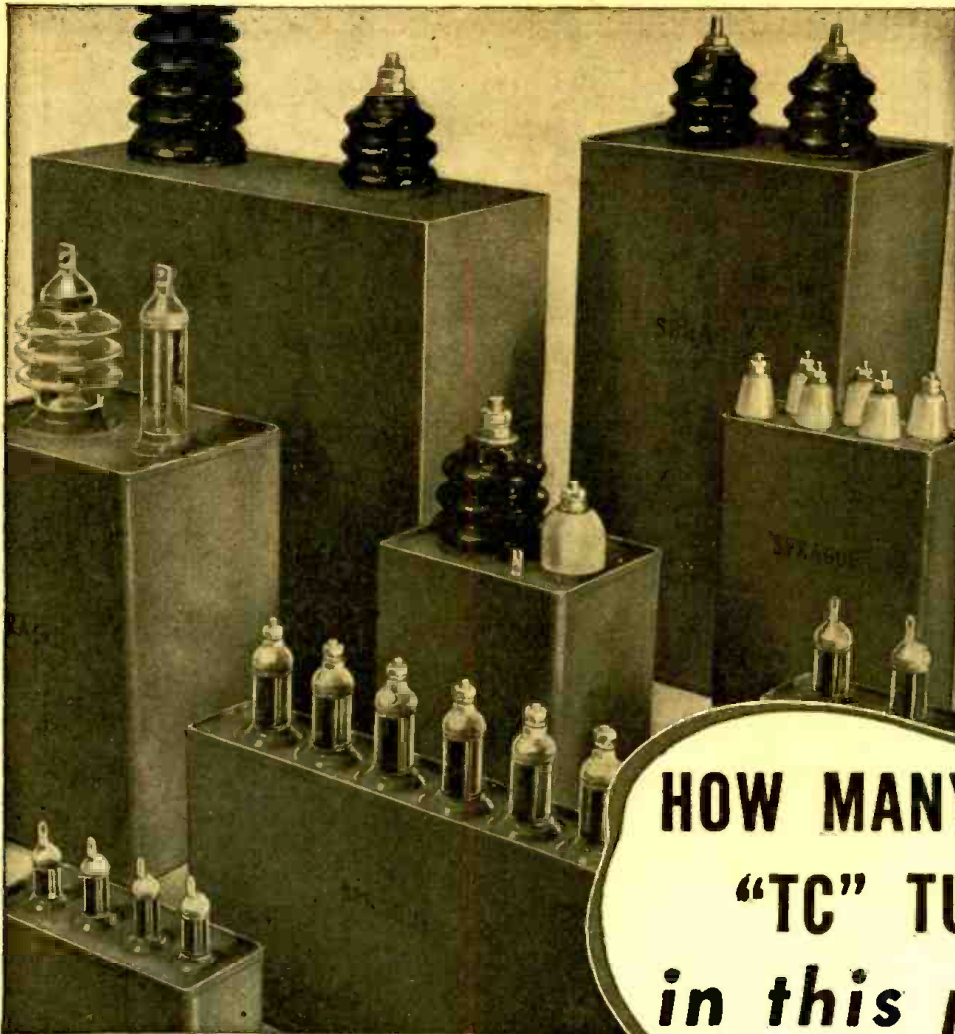

**HOW MANY SPRAGUE
"TC" TUBULARS
in this picture?**

THESSE big energy storage capacitors are recent Sprague Electric Co. types developed for flash-photography, high-voltage networks, welding and other exacting wartime uses.

Consider thousands upon thousands of these giants in terms of the vast quantities of "TC" Tubular Capacitors and other service types that could have been made with the same investment of time and materials, and the Sprague wartime record looms even more impressive.

Every replacement type that has occasionally been missing from jobbers' stocks has been

more than accounted for by the FIVE separate Army-Navy "E" citations that Sprague has achieved. Moreover, a constant and steadily increasing supply of Sprague Atoms and "TC" Tubulars still makes it possible to match 9 out of 10 replacement requirements "on the nose!"

As always — as long as the need exists — see Sprague TRADING POST on Page 779.

Sprague Products Company
North Adams, Mass.

(Jobbing Sales Organization for Products of the Sprague Electric Co.)

SPRAGUE



**"NOT A FAILURE
IN A MILLION!"**

Prepare Now for a Good-Pay Job in . .

RADIO ELECTRONICS

Learn at Home with . .
DEFOREST'S A-B-C
**Syncro-Graphic*
TRAINING!

ONLY DEFOREST'S OFFERS
YOU THE ADVANTAGE OF
MOVIES
TO HELP YOU LEARN
RADIO - ELECTRONICS
FASTER - EASIER
... AT HOME



HERE'S WHAT DEFOREST'S
A-B-C "SYNCRO-GRAPHIC"
TRAINING INCLUDES . . .

A "LEARN-BY-SEEING" MOVIES

To help you master important Radio Fundamentals, you use the more interesting, easier-to-understand, VISUAL method of Movie Instruction . . with a genuine De-Vry Movie Projector and Training Films!

B "LEARN-BY-DOING" EXPERIMENTS

You make 133 Fascinating Experiments with 8 Big Kits of Radio Parts and Assemblies. You build modern Radio Receiving Circuits, Electric Eye Devices, an Aviation Band Circuit, Public Address System, Wireless Microphone, etc. . . all in your spare time, in your own "Home Laboratory."

C 90 "SYNCRO-GRAPHIC" LESSON TEXTS

Prepared under the supervision of Dr. Lee DeForest, the "Father of Radio," inventor of the Audion Tube, and holder of over 300 Radio-Electronic patents.

EMPLOYMENT SERVICE

DeFOREST'S also provides an *Effective Employment Service* which helps you get started in this opportunity field of the future!

DR. LEE DEFOREST supervised the preparation of DEFOREST'S Training



"SYNCRO-GRAPHIC" TRAINING

Makes learning easier because all lesson diagrams and charts are printed on sheets that fold out—keeping illustrations constantly synchronized to text. Eliminates confusion from frequent flipping of pages to refer back or ahead to illustrations mentioned in text. An exclusive DEFOREST'S feature.

Train now for the postwar Radio-Electronic job opportunities which wartime needs and experiences are developing! Use your *free time today* to store-up practical knowledge and experience for *good-pay* tomorrow! Trained men will be needed for the huge postwar requirements of Radio and Electronics, Broadcast Radio, Aviation Radio, Sound Picture Equipment, etc.—in manufacturing, merchandising, installing and servicing.

EARN EXTRA MONEY—While You Learn

When you learn Radio as DeFOREST'S teaches it, you can start a Business of Your Own—be your own boss, if you prefer! Even while learning, you may earn extra money doing Radio Servicing with your home as your "office." Get the facts about this fascinating home training in Radio-Electronics.

SEND FOR FREE INFORMATION!

Get "Victory for You!" book and Equipment folder. See how DeFOREST'S Training can help you towards good pay and a better job in a permanent industry. Also ask about DeFOREST'S Residential Training in the modern Chicago Laboratories shown at left. Mail coupon today.



DEFOREST'S TRAINING INCLUDES INSTRUCTION IN MOTION PICTURE SOUND EQUIPMENT, FM RADIO AND TELEVISION . . .



E. B. DeVry, President
DEFOREST'S TRAINING, INC.
2535-41 North Ashland Avenue, Dept. RC-B9
Chicago 14, Illinois, U.S.A.

Please send me your "VICTORY FOR YOU!" BOOK and EQUIPMENT FOLDER

Name _____ Age _____

Address _____

City _____ Zone _____ State _____

If under 16, check here for special information.

If a veteran of World War II, check here.

DeFOREST'S TRAINING, INC.
CHICAGO 14, ILLINOIS

SYLVANIA NEWS

RADIO SERVICE EDITION

SEPT. Published by SYLVANIA ELECTRIC PRODUCTS INC., Emporium, Pa. 1945

SYLVANIA SERVICEMAN SERVICE

by
FRANK FAX



One of the most direct sources of information about the industry, particularly for radio servicemen, is Sylvania Electric's well-informed 8-page monthly bulletin—*Sylvania News*.

This interesting and helpful paper was started in the early 1930's for the purpose of supplying repairmen with a handy reference file that would contain past and current news of those items that would benefit them most.

Many features of special interest to radio servicemen are dealt with, making the 8-page *Sylvania News* a really helpful bulletin for repair shops all over the country.

Subscriptions are *free* to radio servicemen. To have your name placed on mailing list, just write to Frank Fax, Sylvania Electric, Emporium, Pa.

LEST WE FORGET



THIS STANDS FOR
HONORABLE
SERVICE TO
OUR COUNTRY

WIDE USE OF "LOCK-IN" TUBES BY THE MILITARY SEEN INFLUENCING SET DESIGN

Repairmen Should Prepare For Servicing High Frequency Sets Carrying These Tubes

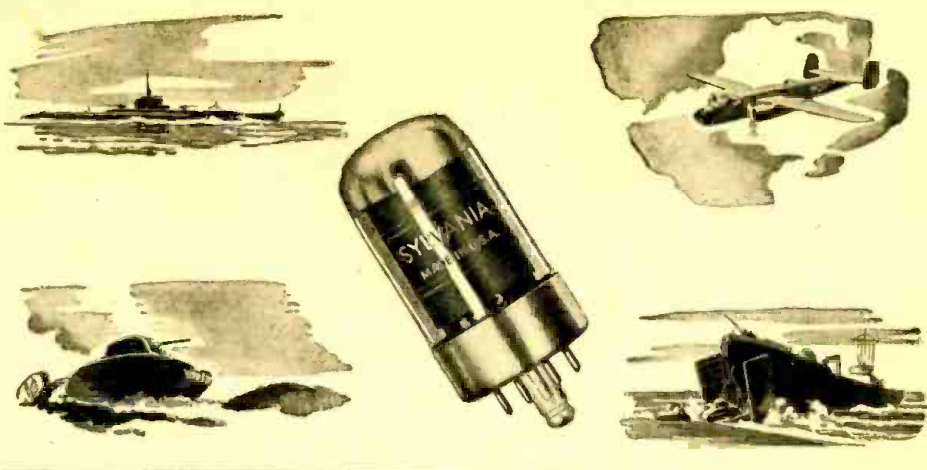

The armed forces have been using millions of Sylvania Lock-In Tubes of various types. During 1944 alone, millions of a *single type* tube, of lock-in construction, were supplied.

Why? Because the mechanical and electrical features of the Sylvania Lock-In are better, more rugged than any other tube made. Most important is the fact that, because of this electrical perfection, the lock-in can handle high and ultra-high frequencies much more efficiently, as necessary for FM and television.



Yes m'am, I carry those radio tubes especially made for this high frequency set.

Because of this special construction the Lock-In Tube has no trouble taking in its stride the recent FCC assignment of the band between 88 and 106 megacycles to frequency modulation. In fact it is right in step with the continuing trend of the industry toward higher frequencies.

SYLVANIA ELECTRIC

Emporium, Pa.

MAKERS OF RADIO TUBES; CATHODE RAY TUBES; ELECTRONIC DEVICES; FLUORESCENT LAMPS, FIXTURES, WIRING DEVICES; ELECTRIC LIGHT BULBS

MAKE MORE MONEY

IN
Radio TELEVISION & ELECTRONICS

Now!

GET THESE 2 BIG BOOKS

FREE!

You men already in Radio know how great the demand is for trained, experienced servicemen, operators and technicians. You know how fast the field is growing and how important it is to keep up with developments — F.M. Receivers, Electronics and Television. You know, too, a fellow cannot learn too much about any industry for **REAL SUCCESS**. Whether you have experience or are merely **INTERESTED** in radio as an amateur, you must recognize the **WONDERFUL OPPORTUNITY** right within your grasp to cash in on your natural abilities. Make them pay dividends. Get into the **EXPERT RADIO SERVICE FIELD**. Be an F.M. and **TELEVISION** specialist—**OWN A BUSINESS OF YOUR OWN**, if you prefer. Fill out and mail the coupon below for all the details of our plan.

Here's Just a Few of the Interesting Facts you Learn with the **FREE MANUAL**.

1. Routine for diagnosing Radio Troubles.
2. Preliminary Inspection of Receivers.
3. How to Check Power Supply.
4. How to Identify Various Stages of Receiver.
5. How to Trace the Circuit and Prepare Skeleton Diagram.
6. How to Test and Measure Voltages.
7. How to Test Speaker in Audio Stages.
8. How to Test Detector, I.F., R.F., and Mixer Stages.
9. Complete Reference Table for Quickly Locating Receiver Troubles.



Get the Latest Inside Information—Short Cuts—Trade Secrets by

SHOP METHOD HOME TRAINING

FROM A REAL ESTABLISHED RESIDENT SCHOOL
 Now the famous National Schools brings its exclusive Shop-Method of training right into your own home. You can learn the most up-to-date, approved projects, systems and circuits step by step in your spare time. This is the sound practical training you want and need—the development of experienced instructors working with thousands of students right in shops, NEW F.M. broadcast studios and experimental laboratories of **NATIONAL SCHOOLS**—one of the most advanced trade educational centers in the world.



National Trained Men Now Making the Best Money in History

The real value of National training shows up on the quick progress our men make on the job. Incomes that seemed fantastic only a short time ago are now being reported by National graduates. And this is only a sample of what the future holds for the **MAN WHO KNOWS RADIO, ELECTRONICS, F.M., TELEVISION** and allied subjects. National is proud of the progress its graduates are making all over the world. Read the facts—the actual proof in the books we send you **FREE**.



LEARN BY DOING

Work with Real Experimental Equipment Furnished without Extra Cost as Part of Your National Training

Experience is the best teacher. You learn by experience with the exclusive National Shop-Method of Home Training. In the course of your study you actually build various types of receivers—a powerful superheterodyne, a signal generator, an audio oscillator and others—You make tests and conduct experiments that show you the why and how of things. You understand what makes the various elements of electronics operate because you actually see them work for you. Not only do you gain marvelous experience by this method of learning but you receive valuable equipment you will use on the job in the practice of your profession as an electronics expert. Mail the coupon and learn what this means to you.

Send the Coupon and prove to yourself what YOU can do in RADIO!

Be Sure Of Your Success And Security After The War

Don't let your post-war ambitions lag. Don't let YOUR future depend on others. Build a career for yourself. Never in all history has the returning serviceman, or war worker been confronted with such a great future if he reaches out and grasps it NOW. Here is a new world opening before you. Get ready now while you are still in uniform—while you are on your war job. Then you can soon step into an essential, well paid position or, with little capital, GET INTO BUSINESS FOR YOURSELF. It isn't a bit too soon to start now. Radio men are vitally needed. Fill out and mail the coupon immediately and examine the **NATIONAL SHOP METHOD HOME TRAINING COURSE** carefully, without obligation.

FREE LESSON INCLUDED

Examine the exclusive National Shop Method of Home Training. See for yourself how sound and practical it is. Be convinced that you can learn Radio, Electronics, Television—quickly and easily in your spare time. You can't tell until you try. This trial is **ABSOLUTELY FREE**. Fill out the coupon immediately while you are thinking about it and drop it in the mail at once. Mail the coupon here for the books that tell you the complete story of the marvelous new system of training in Radio, Electronics and Television. Learn the facts of this exclusive shop-method of home training. See for yourself! **DECIDE FOR YOURSELF!**
 This is the **MODERN SYSTEM OF TRAINING**: it matches the rapid progress constantly being made in Radio, Television and Electronics. It is **TIME TESTED**, too. National Schools has been training men for more than a third of a century. It is the very same training that has helped thousands to more pay and greater opportunity.
 You owe it to yourself—your future—to read the book "Your Future in Radio, Electronics and Television"—**FREE** to you when you send in the coupon.

NATIONAL SCHOOLS

LOS ANGELES 37, CALIFORNIA EST. 1905



MAIL OPPORTUNITY COUPON FOR QUICK ACTION

National Schools, Dept. 9-RC
 4000 South Figueroa Street, Los Angeles 37, California.

(Mail in envelope or paste on penny post card)

Mail me **FREE** the two books mentioned in your ad, including a sample lesson of your course. I understand no salesman will call on me.

NAME AGE

ADDRESS

CITY STATE

Include your zone number

RESERVE YOUR POST-WAR Hallicrafters Communications Receiver NOW



Allied Radio's New Plan Makes it Easy for You to be Among the First to Own and Enjoy this Celebrated Receiver!

MODEL SX-28A—This is the latest model of Hallicrafters famous *Super Sky-Rider* . . . the finest communications receiver built today! Has a frequency range of 550 kc. to 42 Mc. continuous in 6 bands. With crystal, less speaker, net \$223.00

MODEL SX-25—The *Super-Defiant* . . . long-time favorite of amateurs who want fine performance at a moderate price. Has a frequency range of 545 kc. to 42 Mc. continuous in 4 bands. With crystal, less speaker, net \$94.50



MODEL S-20R—Popular *Sky-Champion* offers top performance in low cost field. Has a frequency range of 550 kc. to 43 Mc. continuous in 4 bands. With built-in speaker, net \$60.00

MODEL S-39—*Sky Ranger* portable . . . operates from its own self-contained batteries or 115 volts a.c. or d.c. Has frequency range of 540 kc. to 30.5 Mc. continuous in 4 bands. Net \$110.00

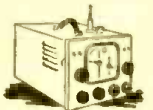

MODEL S-36—Covers both old and new FM bands. Operates on FM, AM, or CW. Outstanding for sensitivity, stability, high fidelity and versatility in the *very high frequencies*. Range from 27.8 Mc. to 143 Mc. continuous in 3 bands. Less speaker, net \$307.50

PM23 SPEAKER—For SX-28A, SX-25 and S-36 above, net \$15.00



HALLICRAFTERS
Honored for its Role in War Communications

On all fronts . . . on land, sea, in the air . . . in jungle, desert and arctic . . . Hallicrafters sets have performed gallantly for the Armed Forces of the United Nations. The fifth Army and Navy "E" award flies from Hallicrafters roof tops! Hallicrafters, you know, are *builders of the famous SCR-299.*



ALLIED RADIO
833 W. Jackson Blvd. Chicago 7, U.S.A.
Over 20 Years of Service to the Nation

TODAY, communications receivers are obtainable only for war use. But as soon as conditions permit, they will again be available for civilian use.

Pent-up demand by short-wave listeners and radio amateurs for world-famous Hallicrafters receivers is *so great that you would be wise to reserve YOUR Hallicrafters NOW!* The record of Hallicrafters performance in war communications is outstanding. Hallicrafters sets have "stood up" almost unbelievably in the most impossible conditions of climate and weather. Vital war-proved features of these sets . . . **PLUS** new advanced engineering developments . . . will be incorporated in your post-war Hallicrafters!

Now, through close cooperation of the Allied Radio Corporation and the Hallicrafters Company, a plan has been evolved that *makes it easy for you to reserve your Hallicrafters at once* . . . and be assured of earliest delivery!

You'll be able to get regular broadcast as well as world-wide short-wave reception.

HERE'S HOW TO RESERVE YOUR HALLICRAFTERS

1. All you have to do is enter your order now with Allied.
2. You don't have to pay the full amount in advance.
3. A deposit of only 10% of the current price will put you among the first in line to receive delivery of a Hallicrafters Receiver.
4. When your set is ready, easy payment terms may be arranged.
5. Any communications receiver, in good condition, will be accepted for a liberal trade-in allowance instead of cash down payment.
6. Even after your reservation is made, you may have your deposit back if you wish.

(Prices subject to possible revision at time of shipment.)



Just imagine how thrilled and proud you will be to rank among the *first* to have a Hallicrafters . . . "The Radio Man's Radio!" Picture the pleasure you'll have . . . for with a Hallicrafters at your fingertips . . . *all the world is your neighbor!* Certainly you want a receiver all your own! To be sure of earliest delivery, enter your order *at once* . . . without delay!

MAIL COUPON TODAY TO RESERVE YOUR HALLICRAFTERS

ALLIED RADIO CORP.
833 W. Jackson Blvd., Dept. 2-JJ-5
Chicago 7, Ill. Date

Please reserve Hallicrafters Model for me. Enclosed is my 10% deposit \$ (It is understood I retain right to cancel order anytime before delivery, and get my deposit back.)

Please send further information on your Communications Receiver Reservation Plan.

NAME

ADDRESS

CITY ZONE STATE

ALLIED RADIO
"Arsenal of Supply"
for Everything in Radio and Electronics

Allied's complete service speeds vital needs to the Armed Forces and Industry. Concentrated here are the world's largest and most complete stocks of parts and equipment under one roof. And Allied has always been one of the leaders in the sale of communications receivers.

The New Radio Receivers

. . . . New radio sets—the first since 1942—are now definitely in sight according to the latest official information. . . . While few civilian sets will be available during 1945, it seems certain that the first quarter of 1946 will see a fair quantity of radio receivers on the market

HUGO GERNSBACK

AS EVERYONE knows the year 1942 saw the end of the manufacture of radio sets for civilian consumption. All radio manufacturers converted for war work and practically no sets have been manufactured since that time.

It is quite true that small amounts of radio receivers were manufactured illegally for black market consumption by so-called bedroom manufacturers, but the quantity produced by them was necessarily small. Such receivers were manufactured mainly from surplus and other spare parts and carried no guarantee, because no maker's nameplate could be put on such sets. The sets also sold at a preposterously high price as do most black market commodities.

It would appear that radio sets for civilian consumption are now definitely in sight and it is quite possible that a modest number of new radios will be manufactured in 1945. There is even a possibility that a few such receivers may be available for the Christmas trade. This is not an over-optimistic view, but it is based upon Government facts. While it is impossible to state in what quantities such sets will be manufactured during the balance of this year, the larger cities probably will have some receivers for sale.

Last month the War Production Board, through its Radio and Radar Division, announced a "Spot Authorization" plan for radio manufacturers to resume the manufacture of radio sets for the civilian trade. This does not mean a general green light for all radio manufacturers to produce sets in unlimited quantities. The new rules for manufacturers issued under the "Spot Authorization" plan means largely that where a manufacturer has on hand idle and excess inventory, such inventory may be used for civilian production of receivers.

If a manufacturer does not have all the material necessary to manufacture sets and if a second manufacturer has an inventory of certain parts which he cannot use himself, the first manufacturer can make application through the War Production Board to use part of the other manufacturer's excess inventory, but he still must make application for it to the War Production Board.

Hedged with such obstacles it seems obvious that no very large amounts of parts can be found to manufacture an unlimited amount of radios. It will be a slow beginning, which will gradually increase in volume and some time in the first or second quarter of 1946 it is quite possible that other restrictions will be lifted. Then an increasing flow of civilian radio sets can be manufactured.

It is interesting to note that General Electric Company predicts the manufacture of fifteen million radio sets, which will be sold in the first full year, following reconversion. This, of course, does not refer to 1946, as it is almost certain that full reconversion will not be effected during that year. A survey made by General Electric Company indicates that the average price of these new fifteen million sets will be around \$30.35. This means there will be a total expenditure by the public of \$455,250,000.00.

According to the same survey, the radio industry sold 13,750,000 radio sets at an average price to the consumer of about \$37.50 in 1941, the last year of full civilian radio production. General Electric based its figures on twenty different surveys and estimates.

It is quite possible that the fifteen million radio receiver figure will fall short of the actual sales because in its survey General Electric considered only regulation home sets.

Many other radio sets, which are already being tooled up for, will be sold. Notable in this category, are the new vest-pocket radio sets, first and exclusively announced in RADIO-CRAFT in its September, 1944, issue. It appears that several manufacturers are now working up their production on such sets. As we go to press, one manufacturer has announced his line, samples of which have already been produced. That many millions of such new type vest-pocket radio sets will be produced right after reconversion seems a reasonable prediction.

Then there will be "in-between sets," not strictly of the vest-pocket variety, sets which may be somewhat larger. These may be termed "pocket radio sets" and camera type radios which started to become so popular

(Continued on page 811)

Radio Thirty-Five Years Ago

In Gernsback Publications

FROM the September, 1910, issue of MODERN ELECTRICS:
The Solid Rectifying Detector, by H. W. Secor.
Wireless and Automobiles, by René Honer.
The Construction of A Small Wireless Transformer, by J. W. Dutmond.
Condenser Radiophone.
New Radiophone Arc.
Wireless in Watch.
Why Do Wireless Waves Travel Farther by Night than by Day? by George F. Worts.

HUGO GERNSBACK	
Founder	
Modern Electrics	1908
Electrical Experimenter	1913
Radio News	1919
Science & Invention	1920
Radio-Craft	1929
Short-Wave Craft	1930
Wireless Association of America	1908

Some of the larger libraries in the country still have copies of Modern Electronics on file for interested readers.

A Good Sending Condenser, by Richard U. Clark.
A Simple Zinc Spark Gap.
A Flame Detector.
Improved Slider.
Pencil Receiver.
New Detector Stand.
Improved Detector.
Duplex Aerial.
A Simple Variable Condenser.
A Bicycle Wireless Outfit.
Efficient Perikon Detector.
A Break-In Key, by M. H. Hammerly.
First Wireless from Aeroplane.

SWALLOW-COUNTING with the aid of electronics can indicate the value of a trainee in actual aerial combat, according to reports issued by Westinghouse last month. In high-altitude flying a definite relationship has been found between the ease or difficulty of compensation of the flier for changes in altitude and his ability as an air fighter. This altitude accommodation is made by swallowing, which equalizes the pressure on both sides of the ear drum or tympanum. Regarding the accommodation as a function of the rate of change of pressure is the chore of the electronic tympanometer.

Heretofore, physicians have had to enter a high-altitude chamber with the prospective flier and count the swallows, and relate them to the rate of change of pressure, i.e., altitude. To make the examination more accurate and obviate the necessity of the physician remaining in the high-altitude chamber during the test, instruments that appear to be oversize earphones with "horns" have been developed at the Westinghouse Research Laboratories. Clamped on the head of the flier, an earpiece over each ear, the swallows are automatically registered by the instruments and recorded on a chart outside the chamber.

Against each ear of the subject are placed fluid-filled chambers. The fluid rests against the ear drum on one side, and on the other against a diaphragm in the "earphone". The "earphone" is a microwave radio transmitter—the "horn" its antenna. The diaphragm, coupled by the liquid to the ear drum, with each swallow moves a pin within the instrument. This movement of the pin causes a peak in the transmitted wave. Thus, the record of a compensation appears as a peak in an otherwise smooth graph.

The problem of transmitting the impulses to the recorder outside the high-altitude chamber is essentially one of telemetering. Because the chamber is a metal enclosure, the receiving antenna is strung inside, emerging by means of a coaxial cable. Accurately plotted graphs of swallows versus altitude (or pressure) are made without the doctor being required to undergo the dis-

Radio-Electronics

Items Interesting

comfort involved in the high-altitude cycle.

Swallowing is a voluntary compensation for differences in altitude. There are other entirely involuntary compensations of great importance in determining the fitness of an individual for high-altitude. The end result of these involuntary accommodations also equalization of pressure on both sides of the tympanum and the rate of response of these to outside pressure variations is also shown.

PROPOSALS to extend the standard-frequency broadcast downward 10 kilocycles, adding a new broadcast channel to the band, were tentatively approved by the FCC last month. The Commission stated that about 54 percent of existing radios will be capable of receiving stations on the new frequency.

Some objection has been raised to the proposal on the ground of possible interference with the 500-Kc. international distress band. This can be avoided by spotting stations on the new frequency in the interior, where there would be no possibility of blanketing coastal areas with strong signals.

The proposal is supported by Howard S. Frazier, chairman of the Radio Technical Planning Board Panel 4 on Standard Broadcasting, who is also chief engineer of the National Association of Broadcasters. Mr. Frazier points out that the new channel would be especially valuable in broadcasting for rural coverage, as the daylight ground wave of a radio station has a greater range at that end of the broadcast band, and the zone of serious fading is further from the transmitter.

PROCEDURE for applying for permission to produce home radio sets and other electronic equipment was announced last month by the Radio and Radar Division of the War Production Board. As a result of this and other lifting of restrictions on materials for home radio manufacture, optimistic predictions of early commercial production are circulating. Some of these insist that the first sets may come off the production line in October. In any case, numbers are likely to be limited till after V-J Day.

Direction 2 to Order L-265, gives instructions for filing Form WPB-4000 for permission to build civilian radios and other electronic equipment restricted by the order, under the provisions of Priorities Regulation 25, the "spot" authorization order.

Applicants for "spot authorization" to produce electronic equipment under PR-25 must include on the WPB-4000 application form a description of each type and model of the product and the quantity (by quarters) to be produced. In addition, for each type and model to be produced, the proposed net unit factory billing value of the equipment and a statement of the quantity of each of the following types of components that are to be used in the manufacture of the equipment must be shown in a letter filed with the application:

Tubes; Transformers and Reactors (excluding intermediate frequency and radio frequency coils); Capacitors, fixed and variable; Resistors, fixed and variable; Loud speakers; Switches; Sockets.

FAVORABLE opinions on the new FM allocations were expressed last month by a number of leaders in the industry.

Though a number of them had pulled for one of the alternate plans, all but a few feel that the final allocation has rendered a real service by putting an end to uncertainty and making it possible to proceed with confidence in the future.

Interference at the new frequencies is expected to be insignificant as compared with the present band, the FCC stated. "Sporadic E" transmissions have been reported by amateurs in the thousands between 56 and 60 megacycles, but none have been accomplished between 112 and 116 mc, just above the present band, according to George Grammer of the A.R.R.L., whose members have operated in both those bands. Interference from the higher F2 layers, frequent enough to be troublesome at times below 84 mc, is negligible on the spectrum.

Among those expressing satisfaction with the new band were William Halligan of the Hallicrafters, John Ballantyne of Philco, and officials of Stromberg-Carlson, General Electric and the American and Mutual Broadcasting Systems. Adverse reports were filed by Arthur Freed of Freed Radio Corporation, and by Commander MacDonald of Zenith Radio. Major Armstrong, who had been the most vigorous opponent of the spectrum finally allotted by the FCC, expressed himself definitely by applying immediately for permission to change his station WFMN to 92,100 Kc.

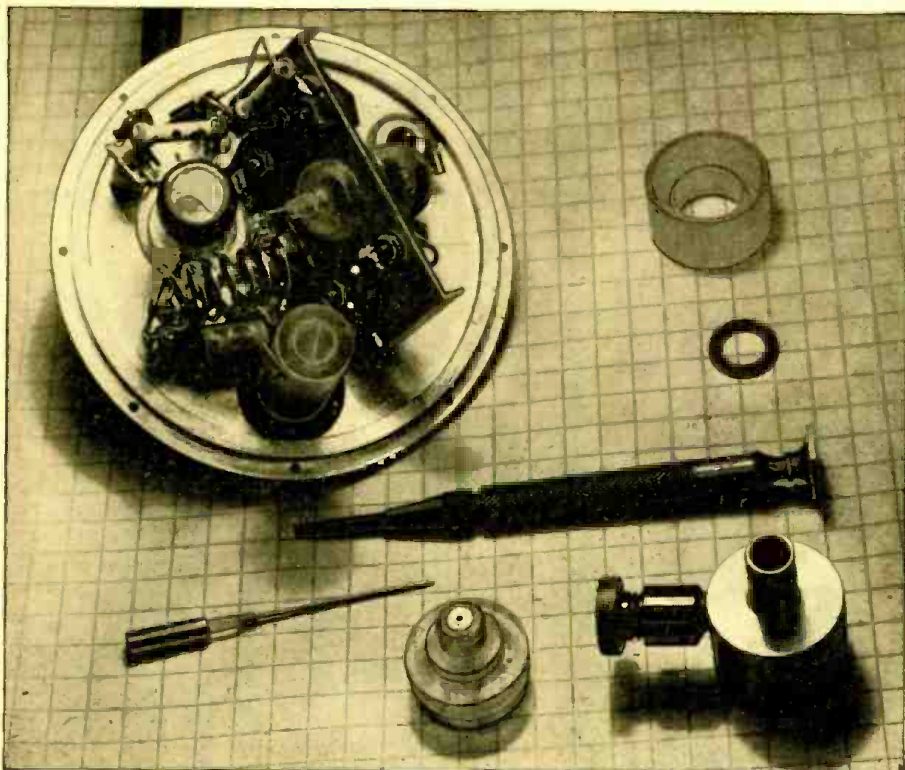

The tiny microwave transmitter fits in a case no larger than a big telephone earpiece.

Monthly Review

to the Technician

ITEMS OF THE RADIO MONTH

Libel by radio is made punishable by penalties ranging up to a \$500 fine and a year in jail by a law passed last month by the Illinois Legislature. Libel is defined by the law as "Malicious defamation broadcast by radio tending to blacken the memory of one who is dead, or to impeach the honesty, integrity, virtue or reputation, or to publish the natural defects of one who is alive, and thereby expose him to public hatred, contempt, ridicule or financial injury."

A mine detector was used by Sgt. Morris Press of the Eighty-Third Infantry Division to find a missing watch. Losing his watch on the banks of the Rhine one evening, he searched for it without success till dark. Next morning he borrowed a mine detector and quickly turned up the missing timepiece.

Radios in Great Britain total 9,710,850— or an average of one for every five persons, according to a survey published last month by the British Post Office, which controls all communications. The figure represents an increase of about 250,000 during the past year.

Electrostatic spraying of paint, in which the object to be sprayed is charged to a high potential in one direction and the paint is oppositely charged, is expected to save from 40 to 60 percent of the paint now wasted in spraying. Not only will all the particles approach and cling to the object sprayed, but their mutual repulsion will tend to promote a more even spray and prevent "thick" and "thin" areas on the part painted.

Radar was among the instruments used in observing the eclipse of the sun last month. Radar instruments were part of the equipment of several scientific parties making observations of the eclipse.

Zoning considerations may interfere with Washington television. Last month the Zoning Adjustment Board of the District of Columbia denied the application of the Bamberger Broadcasting Co. to erect a television tower in a residential district. The decision—which was by a two-to-one vote—was made principally on grounds of commercialization and property depreciation. The decision has attracted a great deal of attention because of its possible recurrence in other cities, though Washington is in a special position because its terrain renders erection of a satisfactory television aerial in any other than a residential area a difficult problem.

ONE BILLION dollars for the development of television in the Soviet Union has been appropriated by the Russian government, according to reports from Washington last month.

The Soviet investment of \$1,000,000,000 in television virtually eclipses the U. S. investment in video to date, which is estimated variously as "upwards of \$30,000,000" or "somewhere below \$50,000,000."

1000-LINE television patent rights for the United States were reported to have been purchased last month from their French owners by Columbia Broadcasting System. Beside the rights for the French high-definition system, the network is said to have purchased a number of other new foreign patents, covering color television. Television engineers from France are expected to hold a demonstration under CBS sponsorship shortly, in which the 1,000-line development will be revealed to sections of the American public.

OWNERSHIP of FM stations will be limited to not more than six for any individual or group proprietor, according to a tentative set of regulations issued last month by the FCC. No person or group shall own, operate or control more than one station in substantially the same service area.

Minimum operation of six hours daily will be required of the FM broadcasters. At least one hour during the daytime period (8 am. to 6 pm.) and one hour during the evening period (6 pm. to 11 pm.) must be devoted to "programs not duplicated simultaneously in the same area by any standard broadcast station or any FM station. During these two one-hour periods a service utilizing the full fidelity capability of the FM station shall be rendered."

TRANSCONTINENTAL communications by microwave are envisioned by Raytheon, which last month received construction permits for five stations to form a relay circuit from New York to Boston. These five are the first leg of the proposed route across the country, which will be extended via Cleveland, Detroit and Chicago to the Pacific coast.

The company received at the same time constructional permits for two FM experimental stations, to be erected atop the Lincoln Building, New York City. One of these, on 105 megacycles, will transmit in a southward direction, while the other, on 107 mc, will beam its transmissions toward the west.

TWO-WAY radiophone between moving automobiles and other motor vehicles and subscribers to the regular land telephone will be in common use in the near future, according to plans announced last month by the American Telephone and Telegraph Co. This will mean that telephones on automobiles, trucks or other mobile units such as boats and barges will be connected with the general telephone system, so that a subscriber to the general two-way mobile service can talk from an equipped vehicle to any one of the millions of telephones served directly by or connected with the Bell companies. Likewise, the occupant of an equipped vehicle can be called from any one of the millions of telephones.

Calls to and from motor vehicles will be handled by special operators. The conversation will travel part of the way by telephone wire and part of the way by radio. If a caller at his desk wants to talk to the occupant of a certain automobile, he first dials or asks for the vehicular operator. He gives her the call number or designation of the vehicle. She sends out a signal on the proper radio channel by dialing the code number assigned to that particular vehicle. An audible or visual signal indicates to the car occupant that he is wanted. He picks up his dashboard telephone and the conversation starts.

The operator of a mobile unit can originate calls merely by picking up his telephone and pushing the "talk" button. This signals the vehicular operator and she "comes in on the line." He gives her the telephone number he wants and the call goes through.

Three classes of mobile service are contemplated:

1. A general two-way telephone service between any regular telephone and any mobile unit, with a three-minute initial period and one-minute overtime period.

2. A special two-way dispatch service between a particular telephone at the dispatching office and specified mobile units. A direct line from the dispatcher to the telephone central office would be furnished as part of this service. A one-minute initial period and the usual one-minute overtime period would probably apply here.

3. A one-way signaling service to mobile units, to notify the operator of the unit that he should comply with some pre-arranged instruction, such as calling his office from the nearest public telephone.

Radio signals in the frequency range between 152 and 162 megacycles have been assigned for the urban mobile service. In general, transmission of these frequencies is greatly improved by mounting transmitting and receiving antennas on high buildings or on other commanding elevations.

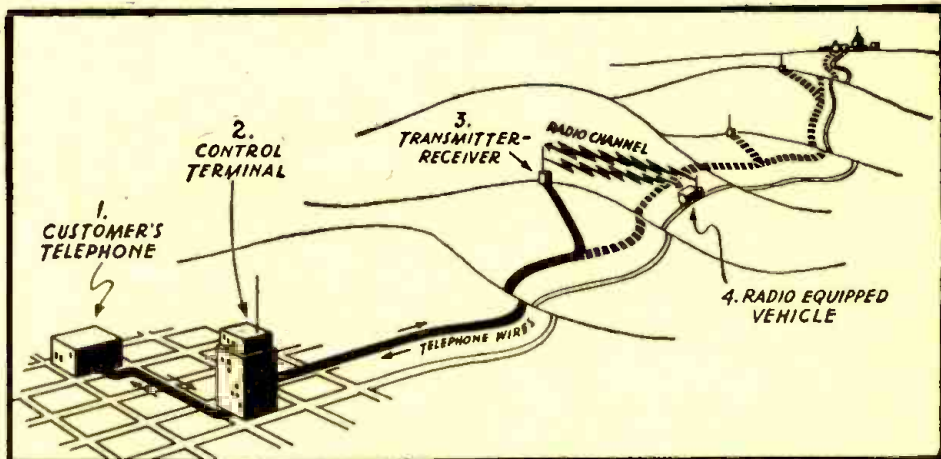

The automobile traveller would remain in touch with his home, even across the continent.

DYNAMIC PHONO PICKUP

Moving-Coil Principle Overcomes Deficiencies of Older Types

THE introduction of a mechano-electric device for translating the groove vibrations of a disc recording into electric current was a revolutionary step forward in the phonograph industry. This device, known as the pickup, made amplification through the vacuum tube amplifier possible, and permitted the broadcast of recordings to a vast radio audience.

Three types of pickups are in general use today: the magnetic, the crystal, and the

By J. M. LEE

or twisted at the opposite end (depending on the type used), has the ability of generating voltage.

A moving coil, or dynamic, pickup consists only of a coil of wire coupled to the reproducing stylus and centered in a magnetic field. Pickups of this type have not been generally available for lateral recordings.

axis of the modulated groove, produces small stylus displacement at high frequencies and a great displacement at low frequencies.

Therefore, in making standard phonograph records it is customary to use constant-amplitude recording for the lower end of the frequency spectrum, crossing over to constant-velocity recording at the high frequencies at a point somewhere between 250 to 1000 cycles.

Since there is no fixed standard for crossover frequency, it has been almost impossible to design a pickup which would respond with any degree of accuracy to the various recording characteristics.

"Ideal" magnetic and moving coil pickups have a constant output at all frequencies from a constant velocity recording. However, in these "ideal" units it is necessary to equalize the output up on the constant-amplitude portion of the record at about six db's per octave below the crossover point, in order to make up for the corresponding downward slope of the recording characteristic.

In the practical consideration, the same two resonance peaks must be met with—the upper or natural resonance period of the stylus armature assembly in the magnetic, and the stylus-coil assembly in the moving coil type pickup.

Because of the physical mass of the armature, the upper resonance peak on most magnetic pickups is within the audible spectrum: between 2500 and 4000 cycles per second. As this peak must be suppressed by damping, the damping block lowers the needle compliance to a high degree of stiffness, causing poor tracking and excessive record wear.

It has been customary for many magnetic pickup manufacturers, in equalizing the falling-off below the crossover point, to use the resonance peak at the lower end of the response curve. This peak is caused by the natural period of vibration of the tone arm impinged against the stiffness of the stylus. This makeshift method results in *one note bass*, and causes severe record wear at frequencies near the arm's resonance point.

One advantage which the moving-coil type pickup has over the magnetic type is that the coil has no tendency to affix itself to either of the poles of the magnetic circuit. This factor allows for maximum stylus compliance. Also, the physical mass of the coil and stylus assembly may be reduced as low as mechanical strength and electrical output desired will permit.

An "ideal" crystal pickup would produce a constant voltage at all frequencies from a constant-amplitude recording, requiring only the introduction of the proper electrical network to equalize the pickup output on the constant-velocity portion of the recording up to that on the constant-amplitude portion. However, the considerable mass of the crystal, stylus, bearing and drive work produces a severe resonance peak between 2500 and 4000 cycles. Some control is exerted on this peak by damping pads on both sides of the crystal. Thus, the rising characteristic up to this peak compensates for the reduced output of the constant-velocity portion of the recording, and the output above the peak falls off rapidly.

The crystal stiffness and the damping also causes a serious resonance at the low-

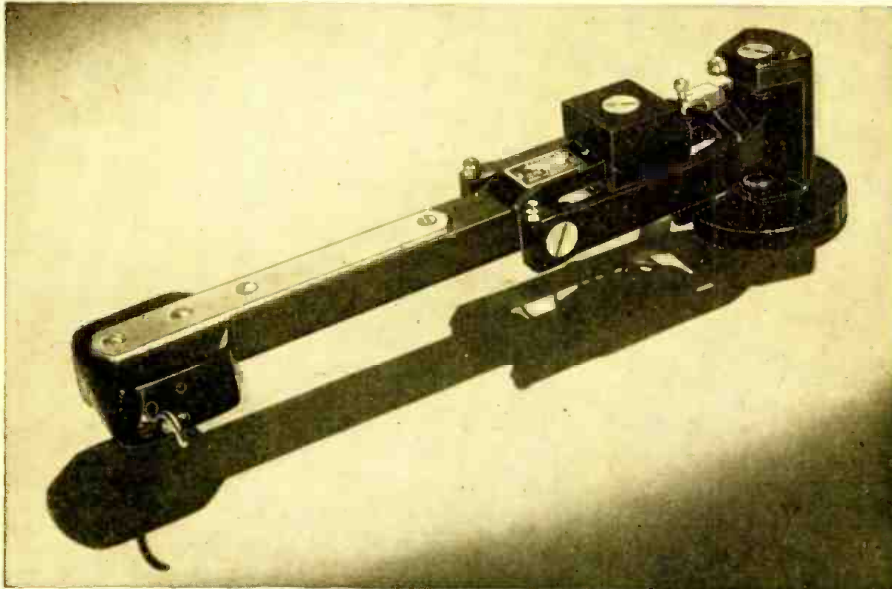

Arm swings horizontally free of record, to which is applied only the pickup head's weight.

moving coil or dynamic. These were developed primarily to reproduce standard commercial phonograph records.

The magnetic pickup employs an armature placed in a magnetic field and coupled mechanically to the reproducing stylus. When the stylus is set in the modulated groove of a record, a coil in the magnetic field, close to the armature, generates an electric current.

In the crystal type, the Rochelle salts crystal, when clamped at one end and bent

Two basic recording characteristics are met with—constant-amplitude and constant-velocity.

Constant-amplitude recording displaces the stylus equally at all frequencies. However, it meets with such a steep wave front at the higher frequencies that it is impossible for the recording and reproducing stylus to produce and track such a groove.

Constant-velocity recording, in which the stylus velocity is constant for all frequencies at the point where it crosses the zero

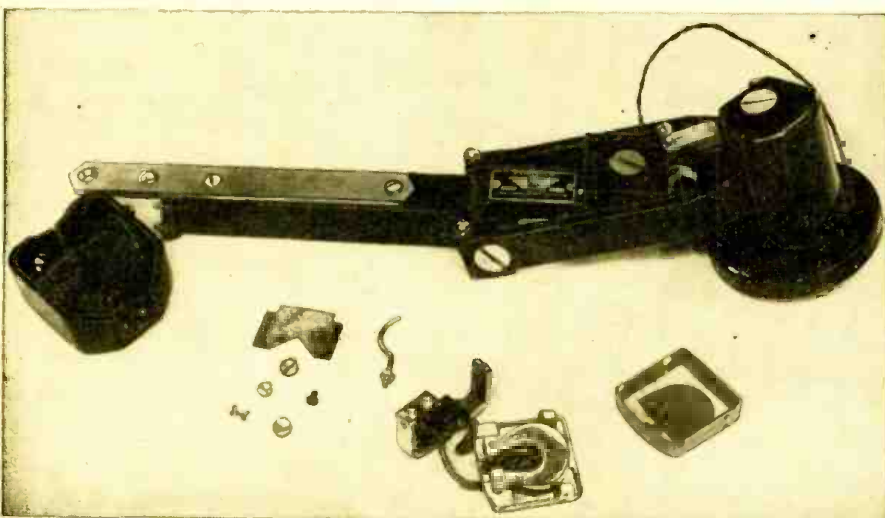

Semi-exploded view of the new pickup, showing jointed arm and the interior pickup head.

er frequencies, from 70 to 100 cycles per second. Only by adding a considerable mass to the tone arm can the frequency of this peak be lowered. Record wear, and often failure of the needle to track the groove at high amplitudes, take place at this frequency. If reasonably satisfactory reproduction is required, a suitable network is necessary to suppress this peak.

Nevertheless, the voltage output of the crystal pickup is high enough to require little amplification, and it offers adequate performance within its frequency range.

The better type of crystal reproducers use a permanent stylus, thereby eliminating the mass of the stylus chuck and needle set screw. This design usually drives the crystal through some form of mechanical attenuator, such as a small tubular member, thus improving the stylus' compliance by introducing a flexible member between the stylus and the relatively stiff crystal element. This improvement in response is accompanied by loss in electrical output.

THE NEW DEVELOPMENT

A new type of dynamic pickup has been developed by Theodore Lindenberg, Jr., sound engineer at Fairfield Camera & Instrument Corporation, which retains reasonable mechanical strength and electrical output, and has a natural high-frequency resonance of 12,000 to 15,000 cycles per second.

The coil in this pickup pivots on its own center of gravity, and the natural period is determined by the mass of the jeweled tip of the stylus. Resonance at this frequency is nearly above the audible hearing range, and amounts to only a couple of decibels in amplitude. To suppress this peak, a very slight cushioning is necessary to keep the stylus in a vertical position. The appearance of the moving member may be seen in Fig. 1.

The natural low-frequency resonance is placed at about 18 cycles, because of the higher degree of stylus compliance and a tone arm of usual mass. This low frequency was purposely selected to avoid the 15-, 30-, 60-, and 120-cycle components, which might appear as vibration from the turntable motor or hum components recorded into the disc.

The very free displacement makes possible a much lighter needle pressure than was formerly practical. In experiments,

perfect tracking was obtained from flat and true-running records with pressure as low as five grams. This low pressure proved impractical, however, and a pressure of 25 to 30 grams produced perfect tracking with negligible wear.

On badly warped records, the inertia of the arm was noted to increase the stylus pressure up to a half-pound on the rising portion of the disc, causing the point to rise completely off the disc on the downward side of the warp. This problem was solved for lateral records by pivoting the pickup head as close to the record as possible, about an inch behind the stylus. Holding the arm above the record at a predetermined point, and with the head floating vertically at the end, the necessary lateral mass and inertia is retained, and reduced vertical inertia keeps stylus pressure below 50 grams.

In developing the new moving-coil reproducer, the designer kept two factors in mind: to keep the mass of all vibrating parts as low and as close to the axis of rotation as possible; to prevent the stylus generating from vertical components in a lateral record or vertical turntable vibration.

To meet these problems, a unique method of stylus pivoting was developed. The coil is wound directly over a very thin split sleeve of silicon steel mounted around one end of a short duralumin stylus. The coil, of No. 46 enamelled wire, has a D.C. resistance of 35 ohms. Two thin plastic vanes extend at right angles to the duralumin stylus, opposite to each other from opposite sides of the coil, and up to the towers of a plastic supporting bridge where their ends are anchored (See Fig. 2). The vanes are in line with the record groove, and in the plane of the stylus. Lateral modulation causes the vanes to flex on the center line of vanes and coil when the jeweled tip of the stylus is placed in the record groove. An oscillatory motion of the coil on its center of gravity result.

STYLUS MOUNTING METHOD

Positive and negative poles of a small Alnico permanent magnet, each faced with a thin cushion of soft synthetic rubber, are placed close to each side of the coil. These may be seen in the "exploded" photograph. The rubber cushions prevent abrasion between the coil and pole pieces, and serve to hold the stylus vertical to the record laterally. These are all mounted on a heavy aluminum plate.

The stylus tip is a tiny diamond pin, ground to a ball

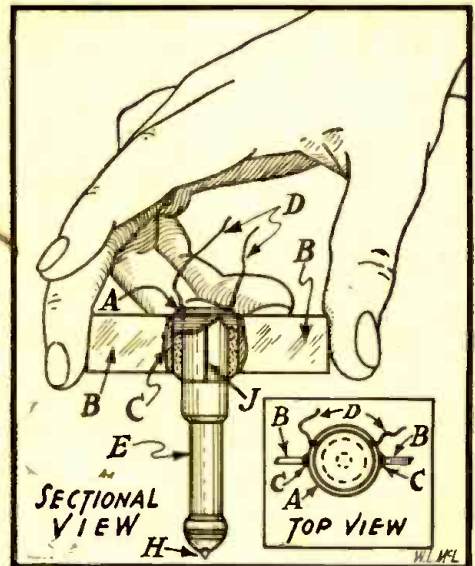

Fig. 1—Stylus assembly. Coding given below.

shape and highly polished to prevent record wear. A diamond tip, properly shaped, eliminates the abrasive action common to the usual steel phonograph needle.

An aluminum casting mounts the head on the end of the reproducer arm. The handle which raises or lowers the reproducer head, protrudes through a slot in the side of this housing. If the head is lifted by the handle as far as the slot allows, the whole arm will rise from an adjustable stop at the rear. Ball bearings at two points on the arm permit free tracking at the low stylus pressure.

Facilities must be provided to equalize the low frequencies below the crossover point of the recording, and to alter this equalization to match the various recording characteristics now in general use. Obtaining low frequency emphasis through mechanical resonance is not recommended.

One method—equalization in the amplifier—offers the necessary bass accentuation. However, a simple unit placed directly in the pickup circuit would be preferable, especially if accurate means can be arrived at for switching to match the unit to the various recording characteristics, and for individual preferences of tonal balance.

The only unit within the pickup which may need replacement, due to accident or misuse, is the pickup head. A substitute head is easily attached with two screws and a small connector plug.

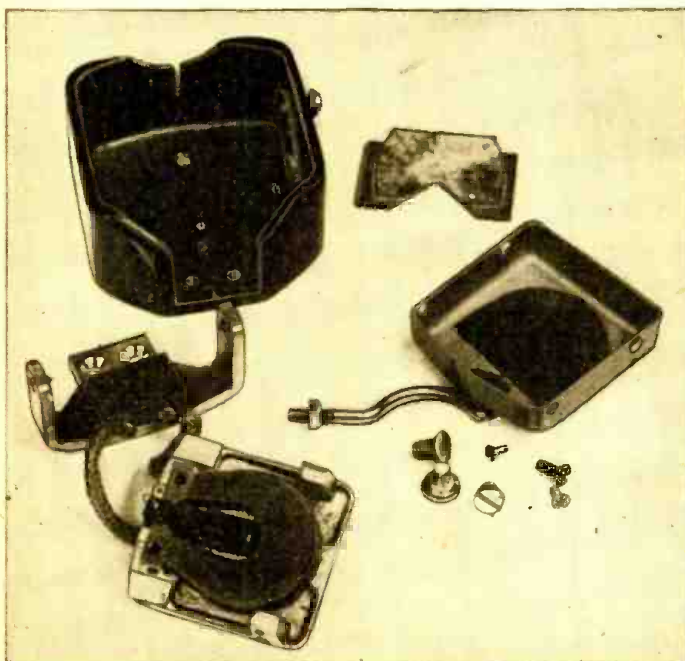

Photo, left—Exploded view of pickup. Fig. 2, below—Stylus in its frame. A—Coil. B—Plastic vane. C—Cement seal. D—Leads. E—Duraluminum stylus. H—Diamond tip. J—Split sleeve. K—Plastic frame.

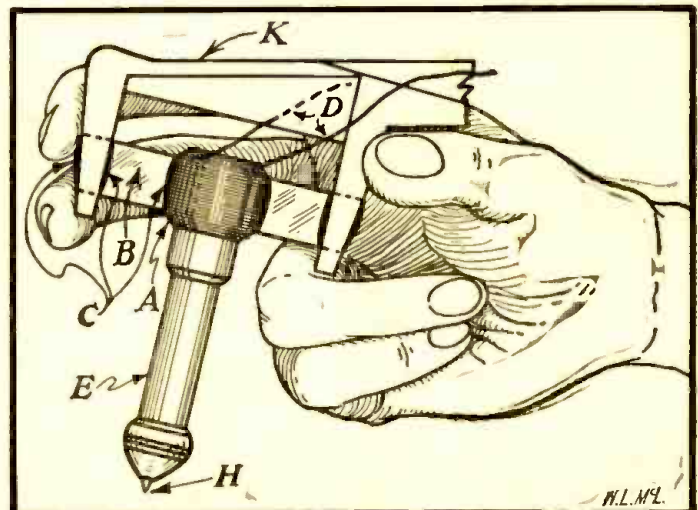

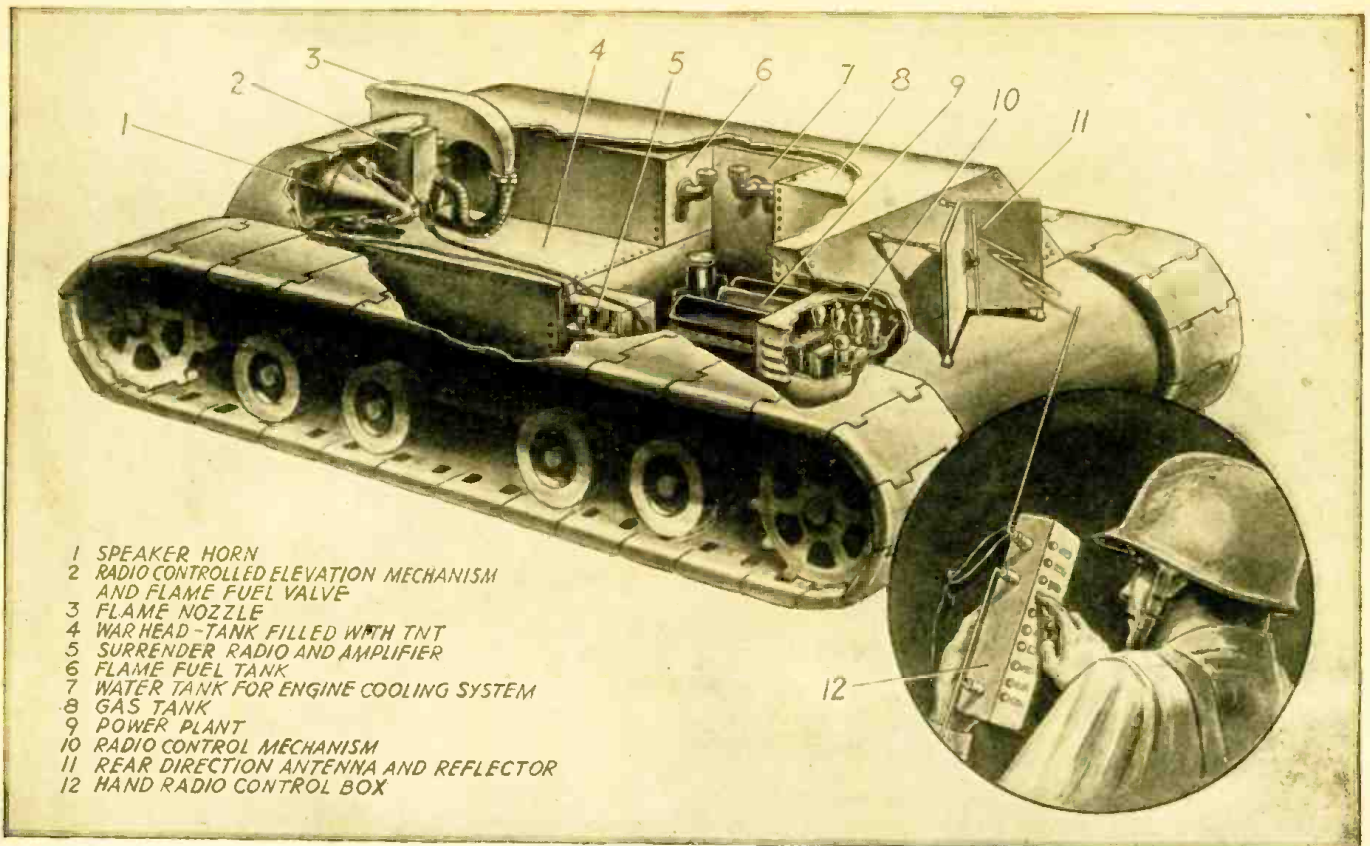

Proposed radio-controlled flame-thrower, surrender speaker and land torpedo, cutaway view. Speaker is also completely radio-controlled.

COVER FEATURE:

Radio Robot Flame Tanks

By HUGO GERNSBACK

DURING the present war, American and Allied troops have suffered large casualties when operating flame throwers, either the portable type that must be carried on foot, or by flame tank*. The reason is that flame throwers have a very short range. The portable flame carrier, or the flame tank, must approach the enemy's stronghold to within one hundred to one hundred fifty feet—often much nearer. This is too close for comfort and if the enemy has hidden snipers or grenades, these can be easily directed on the attacking personnel. For this reason the latter's casualties must always remain high. In the case of a tank, the bazooka type of defense becomes relatively easy to use by the enemy and many tanks are thus put out of action with high casualties.

The Germans in the Italian campaign, and elsewhere, used a number of small explosive tanks of a sacrificial nature, which were used and operated by remote control, chiefly by wire cables which the tank paid out as it proceeded on its mission. These, however, never proved formidable on account of the entanglements of the guiding wires and the ease in which the cables could be cut.

The radio remote controlled flame tank would seem to be the answer to the problem. At the present state of the electronic art it becomes relatively simple to construct special robot flame tanks as shown on the cover and in the accompanying illustration.

*The first man-operated flame tank was described by the present writer in the January, 1936, issue of *SCIENCE AND MECHANICS*. It was first used by Mussolini and the Italians in the Italian campaign against the Ethiopians in the winter of 1936-'37.

These tanks are completely robot controlled and therefore do not require the presence of any human being to operate

There have been far too many unnecessary casualties in this war both in the German, as well as the Japanese campaigns, in connection with flame throwers and flame tanks . . . Flame weapons cannot operate from a distance and therefore become highly vulnerable to enemy fire. Many lives can be saved by remote control operation of radio robot tanks.

them. They are relatively cheap in manufacture and do not require extraordinarily heavy armament, except where they face the enemy. They are safe in operation and cannot be interfered with by the enemy because a directive system of ultra-short waves is used. Reflectors on the back of the tanks are so constructed that only microwaves from the rear can effect their operation. Waves coming from the enemy cannot interfere with or operate these tanks.

Such a standard flame tank would be equipped with the usual flame throwing nozzle with its fuel stored in a tank under high pressure. Trigger valves operated by radio impulses launch the flame, which is instantly ignited. The nozzle is arranged in such a way that it can be elevated or de-

pressed. It need not move from side to side, as the tank itself can move in such a manner that the flame will be directed to the exact spot desired.

A simple gasoline engine operates the small tank or it can also be powered like a torpedo, by compressed air, or alcohol engine. Not carrying a useless load of men, more fuel can be stored on board. The tank therefore becomes much smaller.

The tank will also have a loudspeaker system in the front for surrender purposes, if this is desired. If necessary, a warhead consisting of several hundred pounds of TNT or other powerful explosive, can be built in the front part of the tank. This warhead would be used when the robot is directed against pillboxes. If it becomes necessary to blow up the pillbox itself, the warhead is exploded. This, of course, demolishes the tank as well, but the cost of the individual tank is not too high. Then if a strong point must be taken it can be done at no loss of lives.

Okinawa, where our casualties were extremely high on account of these hidden strong points, has shown conclusively that we need better protection for our attacking troops. The robot flame tank would seem to be a partial answer to this problem.

The radio flame tank may be operated from behind the lines or if necessary from foxholes whereby the attacking personnel can follow the movements of these robots, either by direct vision or by binoculars.

The men who direct the flame tanks need not expose themselves unduly for this purpose and can stay reasonably well under

(Continued on page 810)



ACCOUNTING IN THE RADIO SHOP

By GENE CONKLIN

THE success or failure of any radio serviceshop operative lies in his ability to keep records which are in one both compact, concise and crystal clear. Failure to maintain such records may well place the serviceshop owner behind the well-known and equally undesirable eight ball.

If records are worth keeping at all they are well worth keeping in style! Record forms should always be printed—not mimeographed or multigraphed. In the final analysis the effect of a "printed invoice" upon the recipient or service patron is apt to be favorable while an inartistic if not downright "sloppy" record invoice is literally unworth the paper it is prepared upon.

By the same token figures used as the basis of invoice preparation, names and addresses of service patrons and data regarding such patrons, their radios and their habits as related to their serviceshop patronage must be scrupulously accurate in every respect. Inaccuracy in your "customer file" or in maintenance of any "shop records" will prove a time wasting blockbuster par excellence and will bring you headaches unmitigated by aspirin tablets of any description.

An "hour a day" spent in preparing and maintaining "shop records" of the type described throughout this article will prove sufficient. One of the most desirable hours to be thus spent is at the end of the serviceshop day. Serviceshop portals may be closed to the public and from then a half-hour's work may be well used before the close of the radio serviceman's day. A like period from 8:30 through 9:00 A.M. will complete the "hour daily." The importance of selecting a daily interval for this purpose and sticking to it with the determination of Patton and Eisenhower rolled into one cannot be minimized.

Records may be of value in promoting goodwill and advertising the serviceman's business as well as in keeping him financially abreast of his own business.

Here are a number of records which, if followed through, will cement serviceman-client's friendly feelings.

First and foremost is the "Customer's File Card."

Patron's Name
Address
Telephone Number
Occupation
Sets Owned by Customer
1. Brand Model
2. Brand Model
3. Brand Model
Customer's Interests

"Customer's Interests" is an important feature of this card. The receptionist can ascertain in frequent conversations with clients if there are children in a family (possible sales for used secondary sets intended for Junior's bedroom loom on the horizon), if a member of the family is a DX fiend (chalk up a possible sale of a noise-free antenna), or if an additional speaker in the kitchen would come in handy for the Mrs. to enjoy her favorite programs while preparing the family repast.

By reviewing these "Customer's cards" bi-monthly tube needs can be visualized for the community as a whole. Attached to each card is a duplicate invoice for every service transaction handled between shop and the patron in question. By checking these invoices frequently it is possible to determine when a service-client's auto, bedroom or parlor radio needs a "follow up" exam. This data can then be passed on to the receptionist for prompt action in the form of a telephone call. Each card and invoice should be filed in a separate file folder for prompt and accurate reference.

With regard to the preparation of the customer "invoice" the specimen shown in Fig. 1 is typical of what the well constructed "invoice of tomorrow" will resemble.

From a personal consultation of such file cards it is possible for both serviceman and customer alike to realize exactly what has been bought and paid for in the way of service. The percentage of pickups and deliveries can be charted for both individual and community as a whole. File cards show plainly the period repairs are guaranteed for—hence there can be no question up when a client puts in a request—slightly on the emphatic side—for "repairs on the house."

Nor are customer records the only form of records vital for the radioman to maintain. The ensuing specimens are self-explanatory.

MAGAZINE ARTICLE FILE

COMMUNITY AIR RAID SYSTEM
Constructed for \$49.50
By
In
On page..... to & pages.....

An article file is essential since it enables the radio-service dealer to locate all periodical data on a given subject in the twinkling of an eye. All article cards which have to do with the subject, "Frequency Modulation," for example, can be placed together under a "Master File Card" reading, "F.M."

It is important that the radioman knows the exact amount he owes and for what specific merchandise it is owed. Credit is a lifeline if correctly used. A serviceman who "overlooks" paying bills with promptness is not only unprofessional but is heading for a rude awakening at some not too distant date. The "shipments received file" should be checked semi-weekly in the interests of split-second accuracy. (See Fig. 2 for illustration.)

(Continued on page 799)

Customer's name	Address
Pick Up ()	Date Received
Customer Brings in ()	Date Returned
Set Model	
Man Hours Spent in Repairing Receiver	hrs. @ \$.....
Tubes Replaced	
..... No.'s @ \$.....	
..... No.'s @ \$.....	
..... No.'s @ \$.....	
Component's Replaced	@ \$.....
..... @ \$.....	
..... @ \$.....	
Total \$	Returned to home ()
Guaranteed until	Customer Picked up ()
..... 194..	

Fig. 1—Customer invoice—one copy to customer and one for filing.
Fig. 2—A "Shipment Received" card-index file will avert trouble.

Shipment Received from	Cash ()	Received
..... of	COD ()	In Good Order ()
	Credit ()	Damaged ()
		How Long
Shipment Consisted of		
1		
2		Date Received
3		
4		
5		
6		
7		
8		



A group of young trainees being coached in the operation of a recorder cutter head.



Photos courtesy British Information Service

The Chief Instructor teaching a lesson on broadcast operation to a class of women.



The Instructor explains mechanical details of high-power tubes' water-cooling system.

Making Wartime Engineers

By DR. K. R. STURLEY*

AT the beginning of World War II the British Broadcasting Corporation was faced with the loss of many of its skilled and experienced technical staff to the armed forces, yet its responsibilities were increased by necessary expansion of its technical duties. Redistribution and upgrading of the remaining staff, together with dilution, was the only feasible method of dealing with the problem.

To insure an adequate flow of recruits to man new stations and make good the loss

of the technical problems of the broadcasting service. Lectures are amplified by practical demonstrations and individual coaching. A written and oral examination is used to estimate the capabilities of the student and unsuitable candidates are rejected.

This preliminary course lasting one month is followed by two months' "specialist" tuition, introducing the trainee to the apparatus and run in three parallel sections: transmitting, studios and recording. Transmitter training is established at two of the British Broadcasting Corporation's main transmitting stations, one for short and the other for medium waves, so that students have an opportunity of absorbing atmosphere as well as instruction. The syllabus covers all types of transmitters, their component stages and power supply circuits, methods of amplitude modulation, medium and short wave propagation and aerials.

Studio instruction deals with control room and outside broadcast practice, the acoustic treatment of rooms, the handling of microphones, program metering, reproduction of recorded programs, and line tests; in fact the whole sound chain from the microphone to input of the transmitter's modulation amplifier. A recording center containing all types of the recording and reproducing equipment used by the British Broadcasting Corporation has been chosen for the recording course. General instruction on disc, film and tape recording is supplemented by practical demonstrations and operation of machines by the students themselves.

At the end of each of the three courses, written and oral examinations are held under the direction of the Engineer-in-charge of the school and his senior assistants. As a rule the examination results agree closely with a report of the candidate's subsequent operational ability from his station chief.

engineering was instituted, to be followed, when this source ran dry, by the training of youths (aged 16) and women operators (ages varying from 21 to 30 upwards).

The success of the scheme may be judged from the fact that since its inception about 2,500 persons—a large proportion of the war-time technical staff—have passed through the school, qualifying as technical assistants for operating and maintaining transmitters, recording apparatus and studio control rooms. These trainees have materially helped to maintain the broadcasting service at a comparatively high standard of efficiency. Some, including a few women, have qualified to enter the grade of engineer by passing an examination approaching university standard.

The needs of the upgraded staff were not forgotten, and full-time instructors were appointed to eighteen stations to help them gain greater technical knowledge. Promotion generally followed upon success in an oral examination controlled by the heads of the three branches of Operations and Maintenance. Another object of these instructors is to raise the standard of youths in training to a level at which they can derive maximum benefit from subsequent training provided at the B.B.C. Engineering School.

There are two courses of instruction. The first is a preliminary one covering such subjects as the laws of electromagnetism, acoustics, electromagnetic radiation, in sufficient detail for a general understanding

of youths called up for military service, a scheme of intensive training first of engineers from other branches of electrical

The training school has so proved its usefulness during wartime, that the Corporation regards its continuance in peacetime as an essential part of its policy. To emphasize the importance attached to its

(Continued on page 795)



Demonstrating bass and treble compensation apparatus to a class of youths in training.

of youths called up for military service, a scheme of intensive training first of engineers from other branches of electrical

*Head of the Engineering Training Department, British Broadcasting Corporation.



Radiowomen undergoing training with control-room apparatus. Panel is identical to those used in real service. Bay at left carries incoming programs and bays on right are amplifiers to the individual transmitters.

A DECIBEL NOMOGRAPH

This "equivalent to an infinite number of charts" calculates gains or losses in decibels from the voltage input-output ratios

By NATHANIEL RHITA

MANY problems may be solved by graphical means. An advantage of such representations is the bird's-eye view which results. To connect two variables it is common to plot a chart which is a line or curve, every point of which indicates one variable in terms of the other. Charts may be designed to correlate frequency vs. dial setting, antenna length vs. reactance, plate voltage vs. plate current, etc.

Another type of graph is the nomograph which is useful in certain types of problems. This is usually designed to contain three lines or curves, each calibrated in terms of a variable. The nomograph differs from the ordinary chart in that the reader supplies his own indication by the use of a straight-edge, preferably a celluloid ruler or other transparent straight-edge.

Suppose we wish to show the variation of three quantities: Two may be shown on a chart, but there is no way of showing the third, which will have to be assumed constant. We would need an infinite number of curves on our chart, each corresponding to some value of the third variable. A nomograph is therefore equal to an infinite number of graphs. This is the key to its usefulness.

A useful nomograph is that relating DB gain or loss to voltage or power ratio. The three variables are input, output and decibels. In the figure, the left-hand scale is calibrated in values from 1 microvolt to 100 volts in two sections, A and B. The right-hand scale indicates from one-half volt to 500 volts. The center scale shows decibels in two sections, C corresponding to A and D corresponding to B.

As the nomograph stands it indicates voltage gain or loss, but since current varies directly with voltage in any constant impedance circuit, amperes may be substituted for volts and microamperes for microvolts. To extend to power values the center scale must be divided by two for all readings.

To work out a problem, connect the larger of the two voltages, currents or powers at scale E with the smaller at either A or B by means of the ruler. If the output is larger there is a gain, otherwise a loss. The answer is read off at C or D.

Five lines are shown on the figure as examples.

1—We wish to find the voltage gain of an audio amplifier. Making measurements with a V.T.V.M. we find the output is 55 volts when the input is .15 volts. There is a GAIN of 51.3 DB (Line A).

2—We have an R.F. tuner and after repairing and aligning we wish to find its amplification. Applying a signal generator to an artificial antenna we find an output of 3 volts when 1600 microvolts is measured at the input. The GAIN is 6.5 DB (Line B).

3—How much attenuation must we use to

obtain an output of .51 volts when 20 volts is applied to the attenuator? All impedances are assumed matched. We must design an attenuator to have a 31.9 DB loss (Line C). The same line may be used to show the output when the input and the attenuation are known.

4—As mentioned before, power calculations are the same except that the DB scale is read off as one-half its value. The catalog

lists a particular amplifier as having 10 watts output. What is its power gain (above 6 milliwatts)? Connect 10 at E with 6000 at A. The gain is 64.2 divided by 2, equals 32.1 DB (Line D).

5—Another useful transformation is that of percentage to decibel loss. Amplifiers are sometimes rated in percentage distortion or noise and sometimes in DB down from the rated output. Only two variables are concerned, percentage and decibels. To operate, the ruler is kept fixed against the bottom indication of the left-hand scale at all times. Percentage is read at E, while DB down is read at D. A particular amplifier is known to have 2% distortion. How many DB is this below rated output? The answer is 17 DB below (Line E).

The nomograph below is suitable for most practical purposes. For greater accuracy, a photostatic enlargement of any convenient size may be employed.

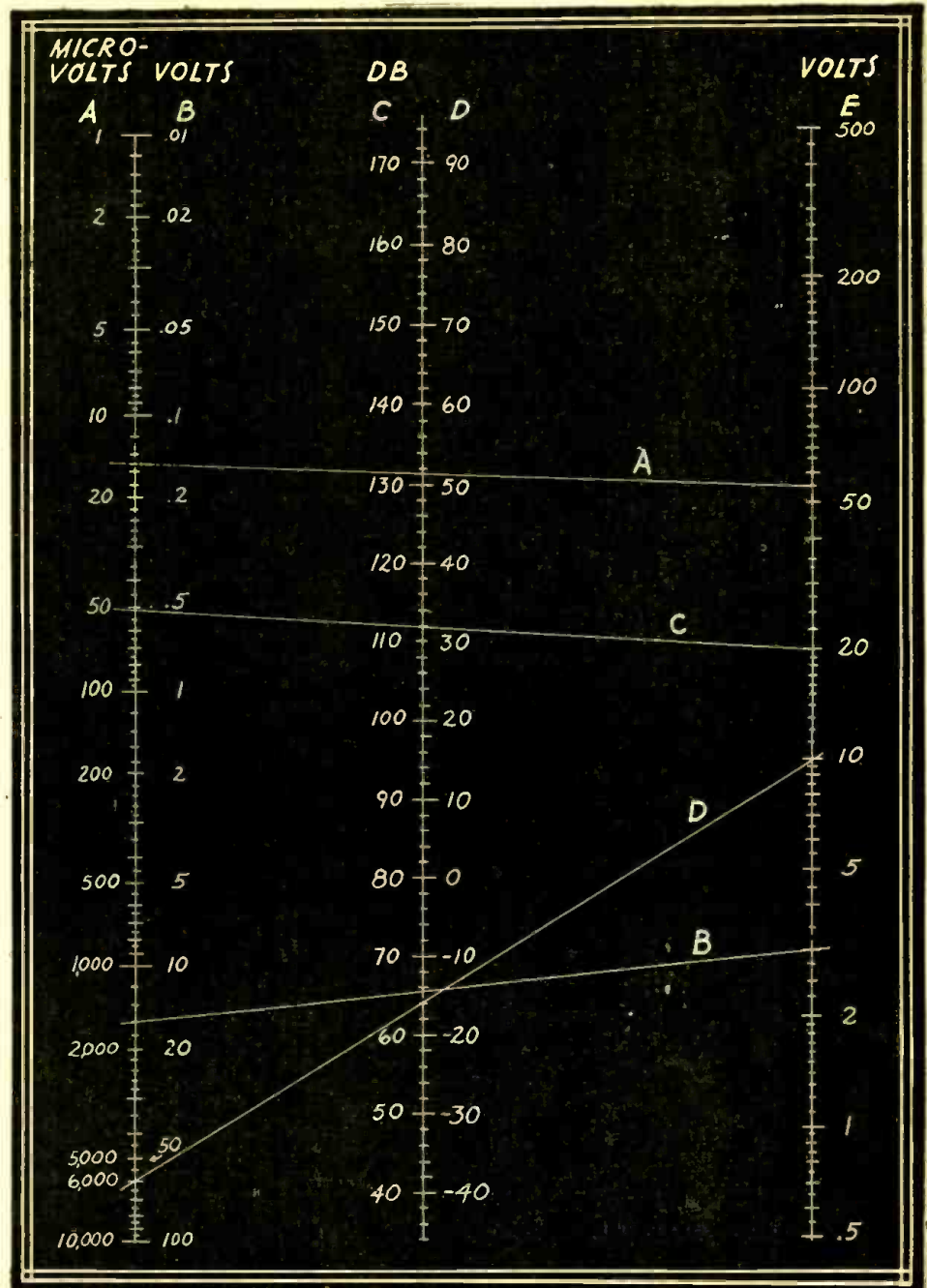

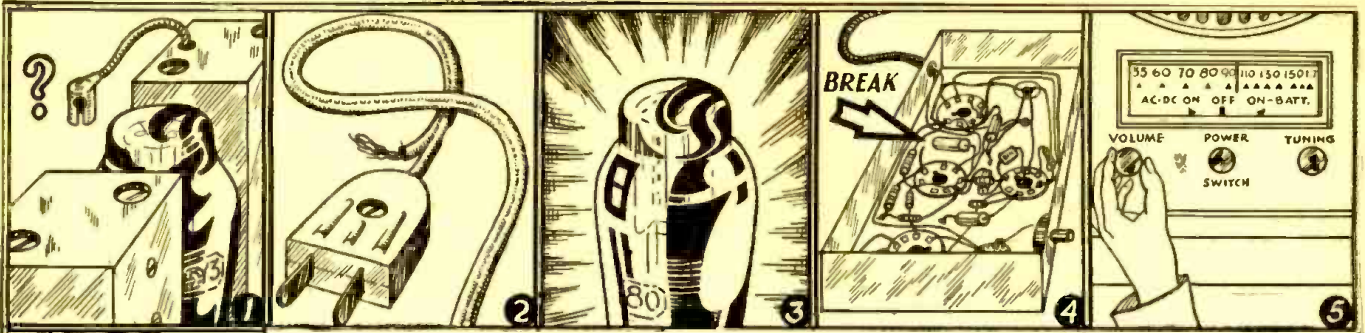

RADIOS SERVICED

Sight, Hearing, Touch, Smell and Taste Are

By LYLE TREAKLE

DURING about fifteen years of radio servicing I have noticed many beginners (and some not beginners!) tinkering with radios and getting nowhere. I have worked with a few so-called "engineers" and have seen them search for many hours to discover trouble that would have been apparent at once if they had but used their knowledge and OBSERVED some things that are quite plain to see.

Careful observation will locate at least seventy-five per cent of all radio troubles. The following system is one I use all the time, and it leads me to the trouble quickly, in most cases. Old-timers will agree that observation is well worth while, but beginners will find the system something they have wished for since they first became interested in "fixing" radios. These instructions are not likely to be of much use to the man who has so much confidence in his native luck that he plunges into a radio chassis with screwdriver, pliers and soldering iron and really "fixes" the set—so that it needs REBUILDING!

All information is as brief and as non-technical as possible so that the novice may derive all possible benefit from the information given.

Let us suppose that we have a six- to ten-tube superhet on the bench and that we are preparing to analyze the trouble. However, this system may be adapted to any other type of circuit also, with proper consideration given to certain differences of circuit action.

1—First, see that all tubes are in their proper sockets. Often the owner has removed the tubes for testing (for free) and frequently replaces them in the wrong sockets.

2—Next, turn on the set. If tubes do not light, check line cord for breaks. On portables especially, check the switch. 3—Watch the rectifier tube for signs of over-heating, plates turning red, etc. Check for shorted filter condensers, shorted sock-

ets or shorted transformer windings. 4—Turn chassis over and look for wires touching, burned-out resistors, etc.

5—Have the dial set on a strong local station and the volume control set at maximum position. 6—Touch the grid cap of the first audio tube, or the grid terminal. This usually can be easily located as the grid lead comes from beneath the chassis. In the case of the single-ended tubes, touch a test prod to the center of the volume control to get the same results as though your finger were placed there. A loud clear buzz should be heard if all is well in the audio end. 7—If not, pull out the power tube. It should make a thump in the speaker if there is voltage on the plate of the tube. 8—If not, check the voice coil. 9—On midgets, make sure the pilot lamp is O.K.

10—Feel the output transformer. These often become warm when excess current is flowing through the plate winding. 11—The small tone-compensating condenser connected from plate to cathode (or ground) may be shorted. Disconnect it and see. Or the coupling condenser may be leaking a positive voltage to the grid, causing the tube to draw excessive current.

12—Listen closely to the speaker. There should be some hum if there is any voltage at all on the power tube. If it is entirely quiet look for an open voice coil or broken leads to the voice coil. 13—Listen to the output transformer. You can hear it singing if the voice coil circuit is broken.

14—Watch any tuning indicator that may be present. If it indicates a signal the R.F. end is probably O.K. Electron-ray indicator tubes appear to burn red when no voltage is supplied to their anodes.

15—Have a test prod on the lead-in from a long antenna. Touch the grid of the I.F. tubes. Noise coming through will indicate the stage is in passable condition. Work back toward the antenna post. 16—Turn the wave-band switch to be sure it is set on the broadcast band. If the noise still comes through, but no signal, the os-

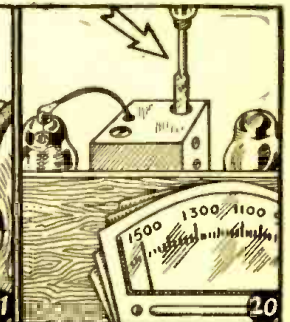
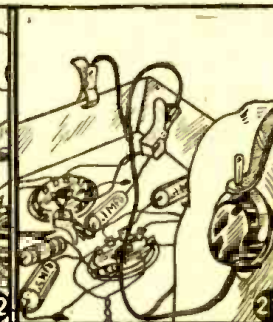
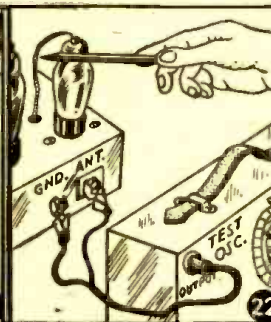
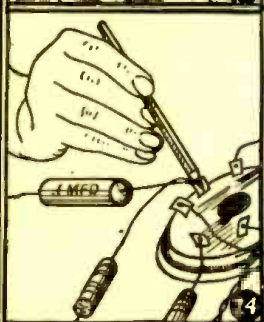
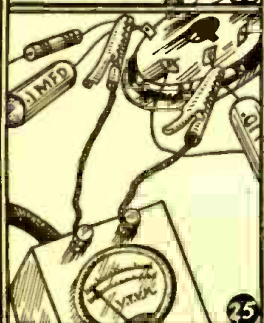
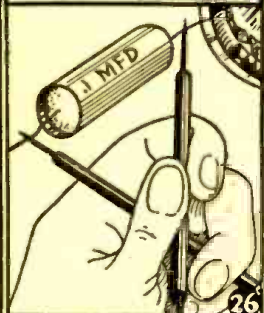
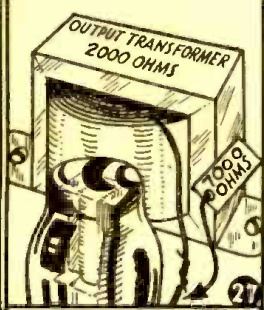
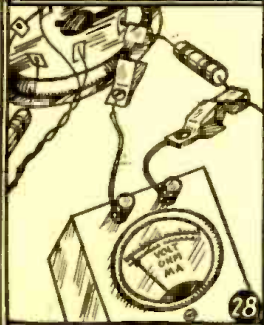

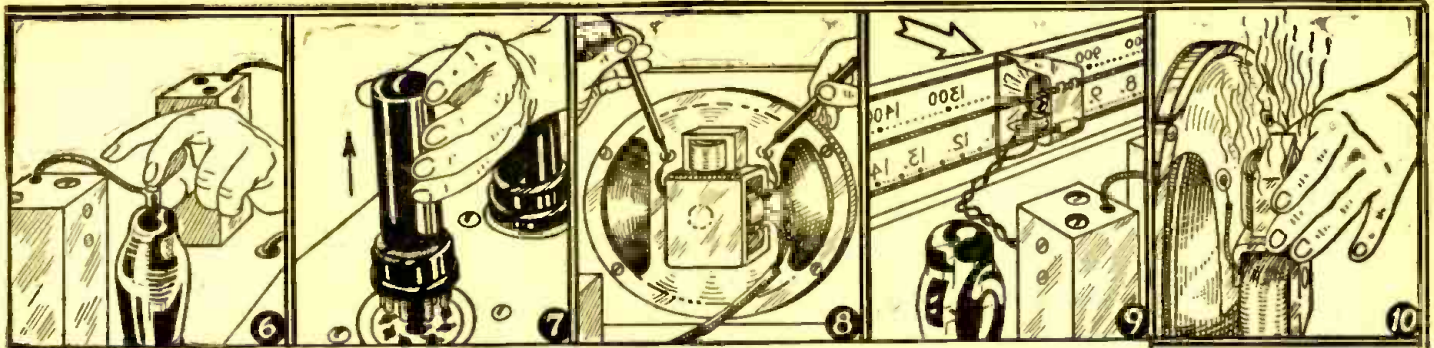

BY OBSERVATION

Valuable Instruments for Checking Receivers

illator is perhaps not functioning. 17—Occasionally a strong signal will force its way through the I.F. Section when the oscillator has stopped. You can double check this by connecting the test oscillator to the grid of the first detector tube and setting it at a frequency of a local station plus the I.F. frequency of the receiver. The signal will come through if that is your only trouble.

18—Try adjusting the I.F. compensating condensers to be sure some home mechanic hasn't discovered they were loose and screwed them down tight. Mark the original setting and don't turn them far off without returning to the original—especially if you have no test oscillator.

This procedure should not have taken over five minutes, and the service man should, with a little reasoning, have a good idea as to where the trouble lies—at least, in which stage it lies.

19—If you are without the test oscillator, you still can do a fair job of alignment on a receiver by using the noise pickup of your antenna. If you should be so (un)fortunate as to have your shop in an interference-free location, generate noise with a buzzer or spark-coil.

Set the dial at a point where no station is heard. Turn up the volume control and adjust the I.F. trimmers for the highest noise level. The noise has very little effect on the AVC action and accurate adjustment can be made in this manner.

20—Next, tune in a station on the high frequency end of the dial and adjust the oscillator trimmer until the station is received best. Move the dial off the station and adjust the R.F. trimmers for maximum noise level. Lastly, set dial at the low frequency and adjust paddler for maximum noise. The broadcast band is now aligned.

(This system will work only on sets with fixed padders in which no accident has caused the oscillator frequency to be "off." Where the paddler has been screwed down so that the intermediate frequency generated by the oscillator is—say—300 kilocycles, an attempt to align will leave the I.F. tuned to 300 Kc instead of the nor-

mal 450-465 used on most radios. The result is that stations will come in only on that part of the dial at which the receiver has been "aligned." Attempts to "align" using the high-frequency end of the dial are equally dependent on the correctness of the oscillator trimmer.—Editor)

Shortwave bands can be aligned also in this manner by using the government monitor station at 2.5, 5, 10 and 15 megacycles to set the oscillator trimmers, and the noise level to adjust the R.F. trimmers. Generally, the short wave bands should be aligned first.

A word or two on cut-out cases. These are in no way difficult. Locate the section giving the trouble. Then concentrate on that section. 21—A pair of headphones clipped in through a small condenser to the grid of the first audio tube will indicate whether the trouble is in the audio end of the receiver. If the signal is still coming through the phones, connect them to the grid of the second audio tube, if the set has one. If signal is also in the phones, go back to the detector. If signal is still heard, the trouble is not in the I.F. or R.F. sections of the set.

22—If a test oscillator is available, connect it to the antenna and tune in the signal. Turn off the modulation. Turn up the volume control. Any loose connections can easily be heard by probing and tapping.

23—When a suspected open condenser is to be bridged with another one on a cut-out job, touch one side in the usual manner, then holding the other lead with the forefinger and thumb, touch the other terminal with the little finger, thereby charging the condenser slowly through the fingers before completing the connection. This will not cause sudden shock which will often make an intermittent radio start operating normally.

24—If the set is full of birdies, an R.F. or I.F. stage may be oscillating. This can be located best by touching the lead of a lead-pencil to the plate

(Continued on page 787)

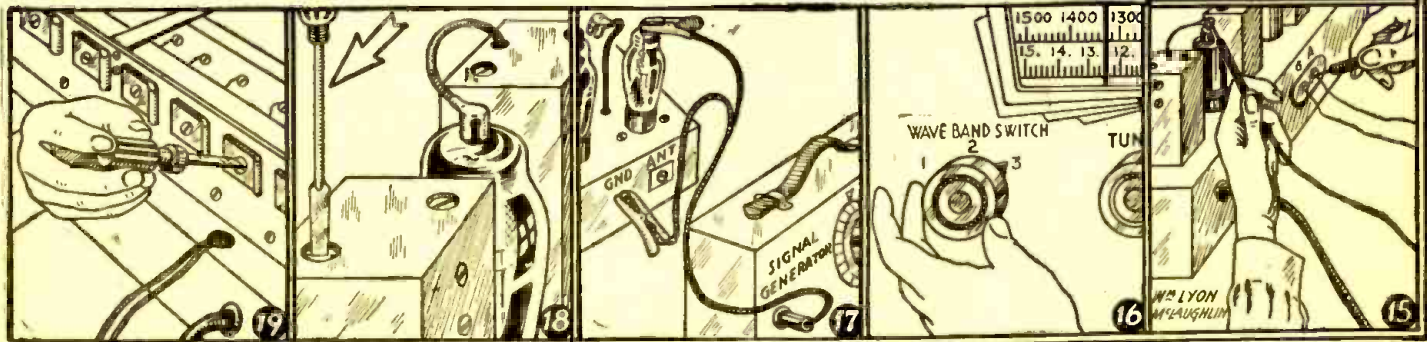
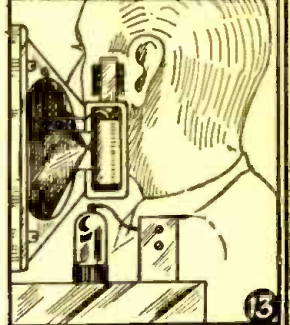
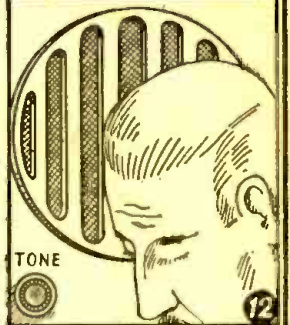
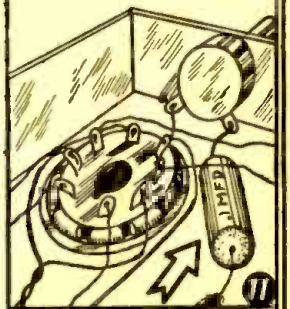

TUBE REPLACEMENTS

PART III—Replacement by Means of Adapters

By I. QUEEN

THE use of socket adapters permits the substitution of tubes which have similar characteristics but different socket connections. Adapters may be purchased completely wired or as top and bottom components to be wired and cemented together. In some cases a resistor or resistance wire may be included internally to drop the voltage to a smaller value for the new tube, if required.

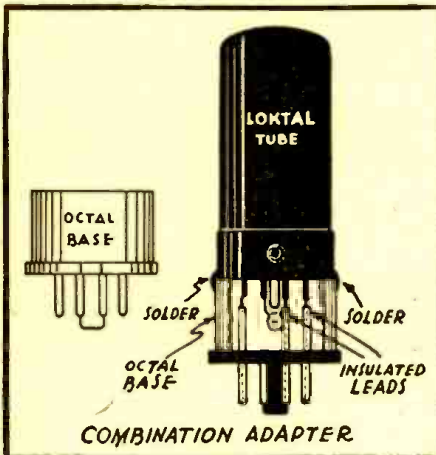

Fig. 1—A practical loktal-octal adapter.

To make up an adapter, the correct top and base are obtained and the corresponding terminals connected with leads. The top corresponds to the new tube, the base to the old. Because of the criss-crossing of leads, spaghetti tubing may be used to insulate them.

The completed adapter may be tested in a tube tester. The new tube is placed in the adapter and the latter is inserted into the tube tester, the controls of which are set for the original tube. If the indication shows "good" the adapter may be assumed to be correctly wired.

An adapter is not necessary in all cases. Frequently, the new and old tubes use the same socket but require different pin connections. Reference to a tube manual shows which wires must be changed, added or disconnected. If space permits an additional socket may be wired in, this giving the advantage that the original factory wiring (which nobody likes to disturb) need not be changed. As soon as the original type of tube becomes available, it is only necessary to remove the added socket and wiring.

An adapter requires additional height which may not be available in compact sets. In such cases the socket will have to be rewired or changed.

Many tubes have a direct equivalent or very similar type in both octal and loktal sockets. The loktals are characterized by small tube size, no top grid connection and special code number or letter. The 6.3-volt types begin with the number 7, the 12.6-volt types with number 14. The designation of low voltage loktal tubes is not completely standardized. The 1LN5, 1LH4 and others are loktals as shown by the letter "L" but the rule has many exceptions.

A simple loktal-to-octal adapter may be made up by the reader from the following

description and the accompanying diagrams Fig. 1 (supplied through courtesy of National Union Radio Corporation).

1. Select a discarded *octal* tube, one preferably having a metal shell base with the same number of prongs as the *loktal* tube you are going to use as a substitute.

2. Break off the *octal* bulb and thoroughly clean out the base. Remove the pin connection wires carefully and make sure that each prong is clear of solder.

3. Now, to each prong of the *loktal* tube, solder a two-inch length of No. 18 or No. 20 wire.

4. Slip a piece of spaghetti about one-half inch long over each of the wires in No. 3.

5. Determine from the basing diagrams of the two tubes to which prong of the *octal* base each prong of the *loktal* tube is to be connected—and then thread the wires down through those prongs.

6. Pull each wire securely through the prong so that the *loktal* base seats flush against the top rim of the *octal* base.

7. Next, solder each wire into its prong and carefully clean any excess solder from the pin.

8. If a metal shell *octal* base has been used, as suggested in No. 1 above, two drops of solder can be applied 180° apart, at the point where the *loktal* base makes contact with the *octal* base. Of course this will not be possible where a bakelite base was used, but even this latter combination will be found to have very good mechanical stability.

When using an adapter it is a good plan to make a side-by-side schematic of the new and old sockets. To avoid confusion, draw the old socket at the left of the new. List the pin numbers and the corresponding elements of the old tube side by side with those of the new tube. After checking, the wiring can begin.

For example, let us replace a defective 1A7G with a 1R5. (Fig. 2.)

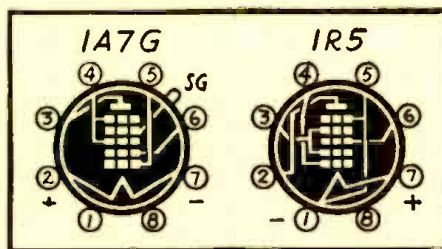

1A7G		1R5	
No connection	1	7 filament (+)	
filament (+)	2	2 plate	
plate	3	4 osc. grid	
screen	4	3 osc. plate	
osc. grid	5	1 filament (-)	
osc. plate	6		
filament (-)	7	6 signal grid	
no connection	8		
signal grid	cap		

The basic differences between the tubes are that the screen of the 1R5 is used as oscillator plate and that a suppressor is added in the latter.

Another example is that of substituting a loktal type for the 6J5 triode. (Fig. 3.)

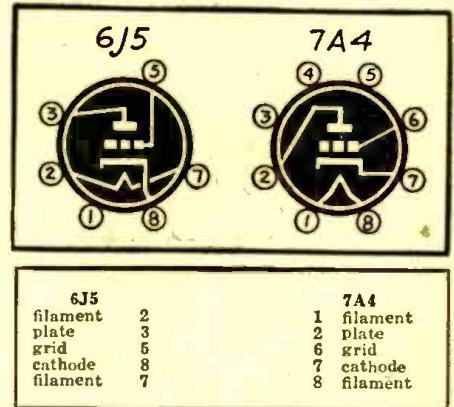

There is one point to remember regarding filament pin connections. With A.C. filaments it makes no difference to which of the pins the leads are connected. However, there is only one correct way of connecting D.C. filament leads. For example, in the previous example involving a 1A7G and a 1R5 the polarity of the filament was noted. Some of the available substitution lists seem to have failed to notice this requirement and consequently recommend incorrect filament pin connections when replacing one type of tube with another. The result may be a loss of efficiency due to change of grid and plate voltages as measured from the negative end of the filament.

Socket changes often involve the change from a grid-cap type of tube to a single-ended type. The original grid lead may then be removed and another wired in directly to its socket pin, or the adapter may be drilled to accommodate a top cap to which the grid lead can be attached. In either case it is a good idea to shield the grid lead, especially inside the adapter, since pickup and hum may result from the nearby filament leads. Always check the set alignment in cases involving adapters or changes in socket wiring.

In most cases a replacement type will require either a change in the filament circuit (discussed in the last part) or a socket change. In a few cases, however, it will be necessary to make both changes to adapt an available tube. If the new voltage is to be decreased it is possible to wire in a resistance or resistance wire inside the adapter, thus making both changes simultaneously. Since the resistor is to be operated in an enclosed space, it should have a power rating far in excess of what it would require in open air.

It is a good idea to check all pin connections when changing wiring in a set. Unused pins, especially No. 1, are often used as supports such as for grounding the shell or for B plus. If the pin arrangement for a substitute tube is different, damage to circuit may result unless changes are made.

In many cases it may be quicker and cheaper to rewire a socket than to build an adapter. There are several considerations that should be noted in such cases—such as the desirability of replacing the original tube when obtainable—which may or may not outweigh the work of construction.

ADAPTER FOR THE V. T. V. M.

By ALFRED SHORTCUT



Photograph of the simple V.T.V.M. adapter.

To gain the full advantage of a vacuum tube voltmeter a circuit must be used with the following features:

- 1—High impedance input on all ranges.
- 2—Isolating resistor in the probe to allow measurements to be made without disturbing signal carrying circuits.
- 3—Polarity reversing switch to make it possible to read plus or minus voltages without reversing the leads.
- 4—Capable of reading high and low voltages.
- 5—Complete meter protection on all ranges.
- 6—Use readily available parts, especially the meter.
- 7—Read 100 megohms or more on a high-ohms scale for measuring leakage resistances.

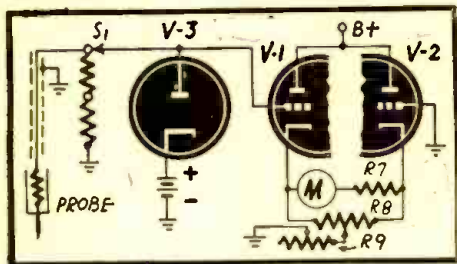

Fig. 1—The V.T.V.M. adapter, basic circuit.

8—Have a zero at the left end of the scale instead of center so that the entire meter scale can be utilized.

Note: Since the average meter will read resistance values up to ten megohms it was not deemed necessary to include these ranges on the adapter.

Since test equipment of any nature is on high priority, a scheme was worked out to use meters which are available in the average shop. This was to be done with an adapter so that the normal use of the meter would not be affected.

On the assumption that 20,000-ohm-per-volt meters are in fairly common use it was decided to build the adapter around the 2.5-volt (or lowest) scale of one of these meters. The vacuum-tube voltmeter was built with pin jacks to connect to the meter. When the vacuum tube meter is not in use the 20,000-ohm-per-volt meter can be disconnected and used normally. In this manner hard-to-get meters are not tied up. Fig. 1 shows the basic circuit, an old and well-known one.

With no voltage applied to the grid of V-1 both tubes conduct and a bias is developed due to current flow through R-8 and R-9. If both tubes were identical then the voltage drop in each cathode circuit would be equal and there would be no voltage difference from cathode to cathode. Since V-1 and V-2 are never quite identical R-8 is made adjustable to accomplish meter zero.

When a voltage to be measured is applied to the grid of V-1 the action is as follows: Assume the voltage to be positive, then the plate current of V-1 will increase. This increase of current through the cathode resistances will cause the cathode voltage to increase with respect to ground. Since R-9 is common to both tubes this increase of plate current through V-1 will increase the bias on V-2 and its plate current will decrease. Thus the cathode of V-1 becomes more positive while the cathode of V-2 becomes less positive and a voltmeter connected between them will indicate.

How much the cathode voltages vary depend on the gain of the tubes and this can be adjusted by R-9. R-9 therefore becomes a calibration adjustment which determines the amount of input voltage necessary to give full scale indication.

If the 2.5-volt scale of a meter is used then the lowest scale on the vacuum tube voltmeter must be 4 or 5 volts.

When a negative voltage is applied to V-1 its current will decrease and the current through V-2 will increase. The meter would read backward in this case so it is necessary to use a D.P.D.T. switch to reverse the external meter connections.

The purpose of V-3 in Fig. 1 is to protect the meter against accidental overloads. Without this tube the plate current of V-1 would be very high in the event a high positive voltage were applied with the meter on a low range. When the voltage at V-1 exceeds 7.5, V-3 will conduct and the voltage drop through the 1 meg. isolating resistor in the probe will prevent the voltage at V-1 from reaching a dangerous value.

ADDING THE HI-OHMS SCALE

The first important thing in the design of any ohmmeter is to have the ohmmeter range be a multiple of the existing meter scale. In the Hickok 133-B (the meter used in the author's model) the Hi-ohms scale was 10 megohms. It was decided to make the V.T.V.M. read 0-100 megohms, since this would multiply the existing scale by 10.

The rules followed in designing the range may be followed for any meter to be used. First, determine the amount of resistance to give half-scale reading on the ohmmeter scale. (In this meter the center of a 100-megohm scale would be 15 megs.) Second, subtract the input resistance of the vacuum-tube voltmeter from this figure. Example, 15 — 11 equals 4 megohms. This value (4 megs.) is the value that must be used for R-6 in the schematic. It should be a close-tolerance resistor if the ohmmeter is to be accurate.

For ohmmeters with different scales the same procedure should be followed to determine the value of R-6.

CONSTRUCTING THE ADAPTER

Fig. 2 shows the complete schematic of the voltmeter. S1 is the range switch, S2 the ohms-volts switch, S3 the polarity reversing switch. The resistors R-1 to R-4 should be as near the indicated values as possible. If semi-precision resistors are not available ordinary resistors may be connected in series to obtain the correct values. These resistors should be measured on a Wheatstone bridge to get the proper values, or measured with a good ohmmeter.

The triode is a single 6SN7, but may just as well be two 6C5 or 6J5 tubes. The diode

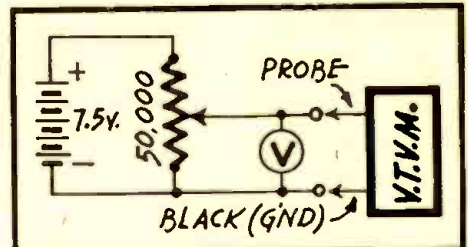

Fig. 3—Equipment for calibrating the meter.

is a 6H6. The .01 condenser should be the best quality available and have zero leakage if possible.

The photo shows the physical construction of the unit. It is fitted into a 9 x 6 x 5-inch crackle-finish box. The front panel is made of aluminum and the letters inked on. After the ink is dry it is a good idea to paint over the lettering with clear lacquer or nail polish to protect the lettering.

After the unit is finished connect the voltmeter to be used with the unit to the output jacks J-4 and J-5. Set the voltmeter to a high range to protect it in case there is a wiring error in the V.T.V.M. Turn the voltmeter on and allow it to warm up. Keep turning the meter zero knob to keep the meter at zero.

After the unit has reached operating temperature set the 20,000-ohms-per-volt meter to its lowest scale. Reset the vacuum-tube voltmeter zero adjustment if necessary and turn it to its lowest range. Connect a 7.5-volt battery and potentiometer as shown in Fig. 3. Connect a good 1000-ohms-per-volt meter or better as shown. Adjust the

(Continued on page 782)

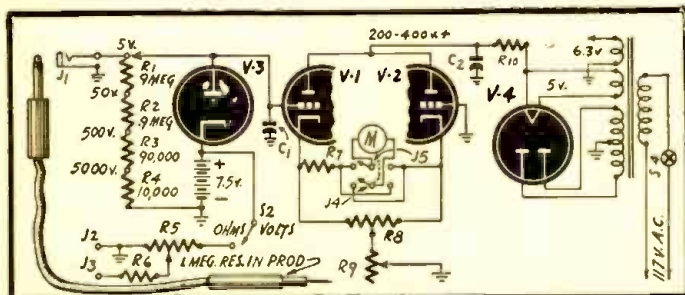

Fig. 2—A novel feature of the circuit is the overload tube V3, by means of which application of higher voltages than 7.5 is rendered impossible.

Beware! The Serviceman!

How to Avoid Being Gyped by this Master Racketeer

By E. A. WITTEN

DO you know that 98% of the servicemen in the United States will gyp you if they get the chance? Yes, of course you do, but do you know what you can do about it? No, Well—this article will tell you all about it.

First, suppose you were to find some day that your Colonial (nineteen-when vintage) did not work some fine morning. You turn the radio off (it had been on all night), and shop around for a radio store. (It really doesn't matter which one as they are all just about as bad.) Try to pick one not too near you. This serves two purposes: One, at least you will have made him earn his money, and two, he won't be as likely to bother you in the future.

When you have decided which one you'd like to try this time, call him up and tell him that you have a big job for him. Make it sound important but act as if you are completely ignorant of what goes on in a radio. Tell him that you want him to call for the set at 11 o'clock that night. He'll be tired then and his sales pressure will be

can tell this at first glance.) If you are satisfied that he won't charge you for his time, you can let him come in.

Now as for the kind of treatment he should get. There are two schools of thought on this subject. I usually prefer to stand over them and watch. You'd be surprised how much you can learn this way. Don't offer to help as this only puts you on a friendly basis with him and he'll try to charge more. If he speaks, grunt or don't answer. After all, he is only a tradesman (like salesmen and plumbers) and should know his place. This makes him nervous and he wants to leave in a hurry and so makes his price that much lower.

Some of my friends try the opposite approach. They treat the radio man with a friendly smile. (This always puts him off guard as he seldom gets that kind of welcome.) Then they invite him in and tell him to sit down in their best chair. Then they give him a cigar. A strong one helps. Two

to give you an estimate without even examining the set. If he has to examine it, watch what he's doing. You can learn his business and fix it yourself the next time. He will follow the usual procedure as outlined below.

First, he will remove the set from the cabinet. He might make faces at dust or roaches, but give him a stern look. It's none of his business what is inside of the cabinet besides the set. He might then try to tap the tubes. **DON'T LET HIM.** His excuse will be something to the effect that he's trying to find a mikrohomie tube or something, but don't fall for that stuff. **THERE IS NO SUCH TUBE LISTED.** I had one serviceman tell me that that was the trouble with my radio once, and I went out to check up on him. I couldn't buy one of those tubes anywhere. Some of those dopey radiomen didn't even know what I was talking about. I finally took the set to a good radio store, and do you know what the trouble was? It was just a burned out I.F. transmitter and a busted speaker input condenser.

SO-CALLED TUBE TESTERS

The serviceman will then test the tubes. This always makes me laugh. Those tube testers are a fake if I ever saw one. The mechanic puts the tube in this gadget and looks up a list telling him what he should do. Then he turns a lot of knobs and pushes some buttons and watches a pointer that looks like a speedometer. He then pushes a button marked "Noise Test." That's how I found out it was a fake. I got the guy to leave the room by telling him that I had another radio for him to look at, and then I listened in on his earphones or headphones or whatever you call them. Now my hearing is unusually good and I couldn't hear even one station or any noise whatever no matter how much I turned those knobs. When I confronted him with this damaging evidence, he had the gall to accuse me of burning up my own tube. Imagine.

Well, I knew I was right but I decided to give him enough rope and let him hang himself. He continued this procedure throughout the rest of the tubes. Then he put in another tube in place of the one he claimed I damaged. He next proceeded to turn the set upside down. Then he poked around and touched this and that. He took out of his bag a condistor or something and stuck it in the set. Then he touched it to the metal box of the set and it nearly scared me out of a year's growth. Big sparks almost two inches long jumped from it. I am still convinced that the sparks that jumped that time damaged the set even more than before. This is just some more of these so-called mechanics' attempts at mystification in order to justify their prices.

OTHER "RUBE GOLDBERGS"

He next proceeded to connect and disconnect a lot of wires and he hooked up a machine that had a funny sound but apparently didn't do anything satisfactory because he soon disconnected it and proceeded to hook in a thing that looked like a television set. It had a lot of knobs like all

(Continued on page 815)

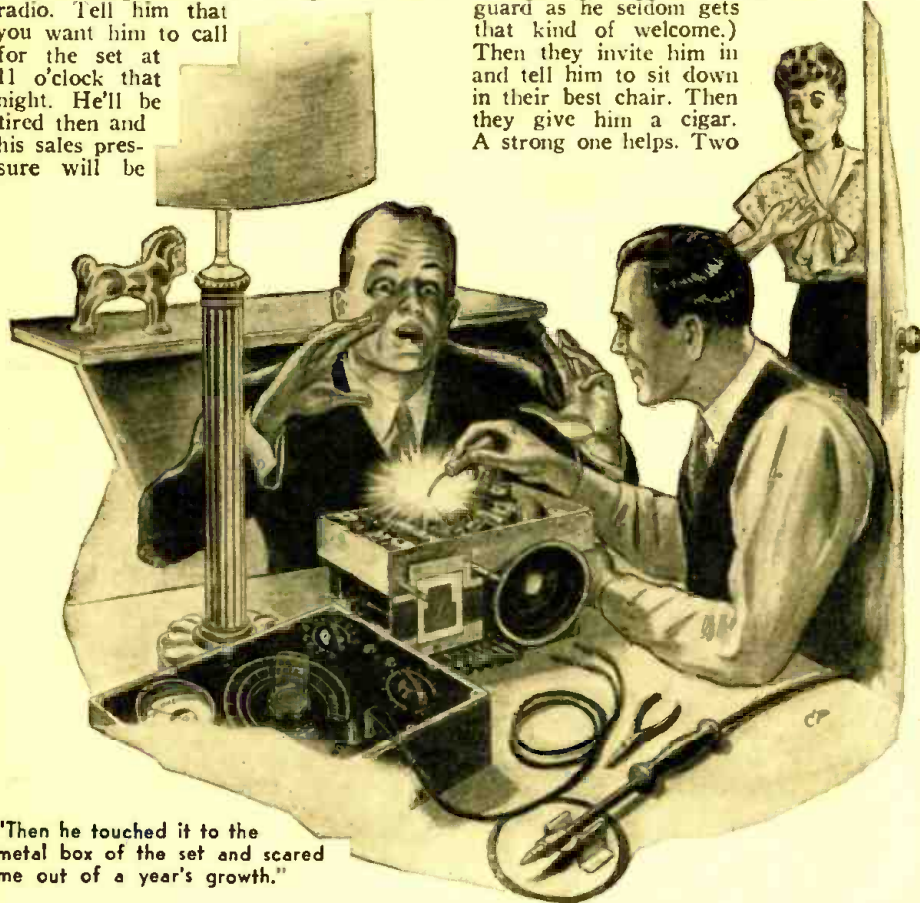

"Then he touched it to the metal box of the set and scared me out of a year's growth."

low so you'll be able to see that he doesn't gyp you.

When he comes, act as if it's just a small matter and doesn't really require attention. Also, see that he carries at least four separate instruments. (This is the test of a good serviceman.) He should have a tube tester, and a gadget that makes a loud piercing noise, and at least two more things that have a lot of buttons and dials and other things. These things aren't really too important in having your set fixed but may help to some extent. Mostly they are just his way of trying to make you think that he is doing a good job.

Before he gets in, find out if he is going to make a service charge in case you decide that he is a crook. (Usually you

purposes are served by this. One: he's likely to be friendly and lower in his price to you, and two: if he has greasy clothes on, or if he drops ashes on your new furniture (how careless of you not to provide him with an ash tray) then you have grounds for a suit. It doesn't matter how old or decrepit the furniture might be or whether his clothes are greasy or not. He can still be bluffed into dropping his charges. Maybe you can even get a new radio out of him.

KEEP YOUR EYE ON HIM

When using this approach, again watch him carefully, to see what you can learn. If he's any good at all, he should be able

BROADCAST EQUIPMENT

PART XI — Frequency and Modulation Monitors

By DON C. HOEFLER

THE frequency monitor is an essential component of any broadcast transmitting station, for the purpose of measuring the carrier frequency deviation of the transmitter. An F.C.C. requirement states that the instrument must be an approved type with a stability and accuracy of at least five parts per million. The Western Electric No. 1-A frequency monitoring unit, illustrated in Fig. 1, is a typical approved type, which checks the transmitter operating frequency by comparing it with that of another crystal-controlled oscillator. It may at first consideration seem rather paradoxical to merely compare the operation of two pieces of identical or similar equipment, but no better method of checking frequency has yet been devised, and this one does perform its required function satisfactorily. This is so because the monitor is operating under constant and ideal conditions, with no variations in load, and thus serves as a fairly reliable checking instrument. The reference oscillator with its temperature control equipment is an integral part of the monitoring unit, and is adjusted to the assigned frequency of the station. The remainder of the equipment includes two radio-frequency amplifiers, a detector, a visual frequency-difference indicator, and complete power equipment. The voltage to be checked by this equipment can be obtained from any transmitter stage, from an antenna near the transmitter, or from a receiver tuned to the station's frequency. However, it is preferable to monitor an unmodulated stage, as modulation introduces an error into the indications. Otherwise, readings can only be taken when no modulation is present.

FREQUENCY MONITOR OPERATION

The theoretical operation when used with an antenna is as follows: when R.F. from the transmitter is picked up by the small antenna, it is applied to amplifier tube V-1 through voltage-divider R₁. At the same time the R.F. from oscillator V-4 is applied to amplifier V-3. R.F. transformer T₁ acts as the plate load for both amplifier tubes, and simultaneously applies their outputs to mixer tube V-2. At this point the two R.F. voltages beat together, producing sum and difference frequencies in addition to the two original frequencies. In the plate circuit of the detector, then, are four voltages; three of them are R.F., and one is a very

low frequency, probably only a few cycles. The three R.F. voltages cannot pass through the high reactance of relay winding X₁, but are instead by-passed to ground through condenser C₁. The low-frequency voltage, meanwhile, which is an indicator of the frequency deviation because it is the difference between the standard oscillator and the transmitter output, readily passes through the reactive circuit C₂X₁. R₂ is short-circuited by manually closing push-button S₁. This permits sufficient current to pass to energize the sensitive relay which closes contact A. Then a positive charging voltage is applied to condenser C₃ as long

the transmitter, he must know whether the deviation is above or below the assigned frequency.

This is accomplished by temporarily varying the local oscillator, and thus varying the beat frequency. C₃ is a small trimmer whose capacitance is slowly varied by depressing a push-button which increases the spacing between the plates and decreases the oscillator frequency. Thus if the transmitter frequency is low, the beat note becomes lower and the meter deflects downward. Likewise, if the frequency is high, the meter will deflect in an upward direction.

In addition to the test adjustment C₃, another trimming condenser C₄ is connected

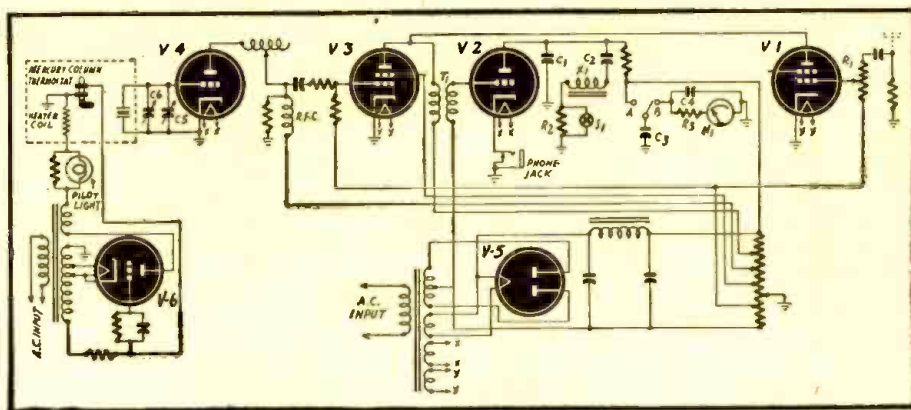

Fig. 1—The Western Electric frequency monitor. Its operation is explained in the text.

as the relay arm is in this position. When the rectified low-frequency pulse through X₁ expires, the relay arm swings back to close contact B, and C₃ discharges through the frequency-deviation indicator M₁. Since the low frequency has a definite period, it determines the quantity of charge of C₃, as $Q = I \times T$ and the current is constant. The time constant of R₂C₃ determines the discharge rate of C₃ through the meter, which is calibrated directly in cycles. Whenever there is a difference between the transmitter and oscillator frequencies, there will be a low-frequency beat note in the plate circuit of the detector exciting the indicating circuit. In order for the station engineer to make corrective adjustments to

across the quartz crystal to permit limited frequency adjustment. At the time of calibration, the condenser control is set to zero on a scale, indicating half-capacity, and this should never be changed unless the monitoring service of a recognized authority indicates the necessity of so doing. It is very desirable to determine periodically the accuracy of the frequency monitor by comparison with a laboratory standard. Almost every large city has an organization approved by the F.C.C. to provide this service. If at all possible, it is advisable to make this check instantaneously by telephone.

(Continued on page 806)

Right—Outside view of Western Electric 1-A frequency monitor unit.
Below—RCA 66D modulation monitor, similar to the 66A described.

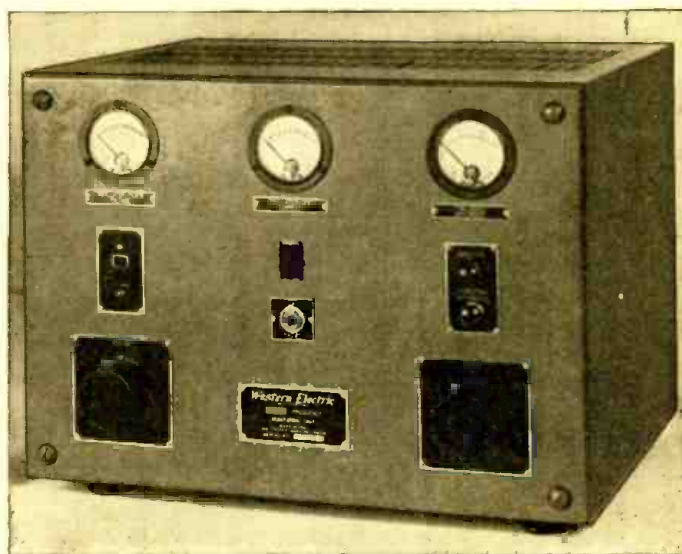
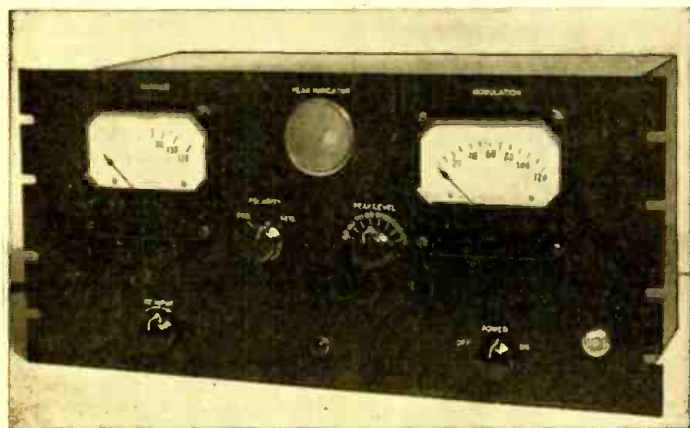

DETECTOR CIRCUITS

PART II—Hi-Fidelity Triode Detectors; The Plate Rectifier, Infinite-Impedance Detectors. Grid Rectification and Regenerative Circuits.

By ROBERT F. SCOTT

WITH the exception of the diode, the Plate Detector is perhaps the most commonly used of the remaining types of detectors. This type of detector may employ either triode or pentode tubes with equal efficiency. A typical circuit for the plate detector using a triode tube is shown in Figure 1.

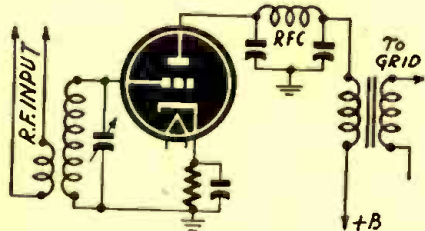

Fig. 1—A typical plate rectification circuit.

For efficient operation of the plate detector, it is necessary that the grid of the tube be biased to the point of plate current cut-off and a fairly large signal be applied to the input circuit. Since the plate current is at cut-off, there will be no flow of current on the negative halves of the input cycle, but on the positive portion of the cycle the signal will remove an effective part of the applied bias and current will flow in the plate circuit. This current will

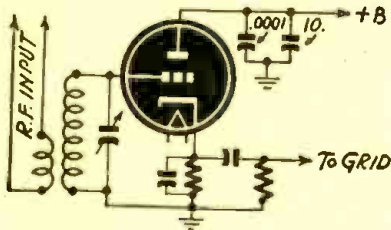

Fig. 2—Standard infinite-impedance detector.

be proportional to the amplitude of the modulating envelope. When this current is caused to flow through suitable R.F. filters and a resistive or impedance load, the voltage drop across this load may be applied to the grid of a following stage for amplification. Since the major portion of the characteristic curve which is employed is linear, little distortion will be introduced into the circuit due to the detector.

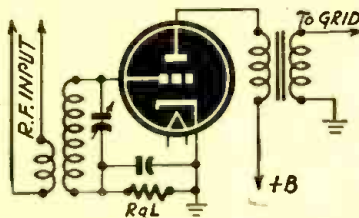

Fig. 3—Grid-leak is like a diode detector.

This slight distortion is due only to the small curved portion at the foot of the operating curve. Hence, it is clear that the distortion is lessened by the use of high input voltages.

When a triode tube is utilized as a plate detector, either resistance or impedance may be employed as the plate load with almost equal effectiveness. The pentode demands an impedance in its plate circuit, because of the high internal plate resistance. The pentode is the ideal tube for this service due to the high amplification which may be obtained from the circuit. Frequency response may be calculated if the tube is looked at as a class A amplifier tube. Aside from the amplification which is possible with this type of detector; there is a definite advantage which makes it popular in most commercial equipment where sensitivity and selectivity are essential. This factor is that the plate detector does not load the tuned circuits feeding it. This type of detector is often called the "linear plate detector."

INFINITE-IMPEDANCE DETECTOR

When the ultimate in high fidelity is desired of a detector, it will be found that the circuit shown in Fig. 2 will meet practically all requirements, a glance reveals that it seems to be a hybrid between the plate detector and cathode-follower amplifier. It is also similar to the amplifiers in oscilloscope circuits and the detectors in some types of vacuum-tube voltmeters. This circuit does not load the preceding tuned circuits in any manner and its effective input resistance is very high. Hence this circuit is called the "infinite impedance" detector.

It will be noticed that there is no resistance or impedance in the plate circuit of the tube. In this case, the resistance in the cathode serves a dual purpose by supplying the necessary grid bias voltage and acting as a load in the plate circuit. The loading of the plate circuit is possible because the plate current completes its circuit via the cathode.

When a modulated signal is applied to the input circuit the positive peaks will cause the plate current and consequently the current through the resistor in the cathode circuit to rise. This rise in current causes an additional voltage drop in the resistor which is equal to the current change times the value of the resistor. Since the cathode is by-passed only for R.F. currents, the audio currents are forced through the resistor. The variable voltage drop across the resistor follows the shape of the modulating envelope. The plate circuit is by-passed for both audio and radio frequencies to prevent stray currents from entering the power supply.

INVERSE FEEDBACK EFFECT

It is known that when the load is common to both grid and plate circuits, degeneration or inverse feedback takes place and the gain of the tube is reduced to a great extent. This loss in gain is more than compensated for when we consider that one of the advantages of degeneration is the drastic reduction of all distortion originating within the circuit to which the feedback is applied.

The resistance in the cathode is so selected as to reduce the plate current to a low value with no signal input. When a signal is applied plate current will flow during the positive peaks. This current flowing through the resistor will increase the bias and thus reduce the gain of the stage. In this case, the feedback ratio is one-to-one. This limits the gain to unity. For this reason the infinite-impedance detector is comparable to the diode with identical signal input.

Unlike the diode, this detector is not easily overloaded by a strong carrier or high modulation peaks because the greater the signal value becomes, the more effective bias is applied to the grid.

In all of the detectors discussed thus far, rectification of the signal takes place in the plate circuit. Now we will begin the discussion of a simple circuit in which the demodulation takes place in the grid circuit. Compare Fig. 3 with the simple diode circuit

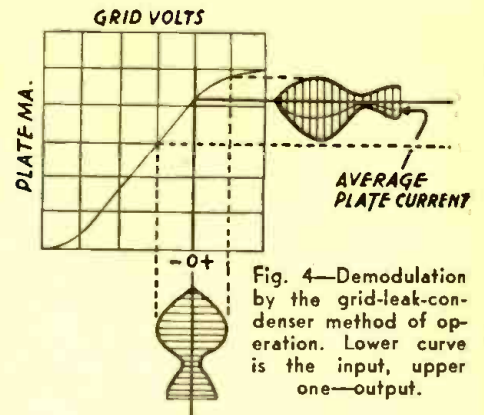

Fig. 4—Demodulation by the grid-leak-condenser method of operation. Lower curve is the input, upper one—output.

with the grid having the action of an anode when it is allowed to go positive.

LEAK-CONDENSER DETECTORS

It will be seen that the only source of grid bias would be from the resistor in the circuit. When no signal is applied to the input circuit, the plate current will reach its maximum value for the applied value of plate supply voltage. From Fig. 4 we observe what happens when a modulated signal is applied to the input circuit. When the grid is driven positive, the plate current increases somewhat, but not linearly, due

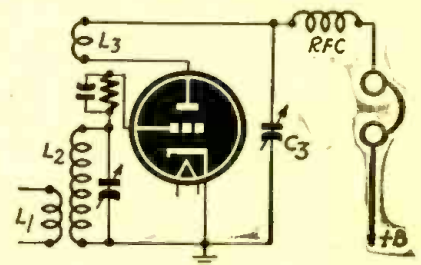

Fig. 5—Typical grid-leak-condenser circuit.

to the curvature at the uppermost end of the grid-voltage-plate-current characteristic curve. The negative portion of the input cycle reduces the plate current. This reduction is within the linear part of the curve and the average plate current for this portion of the cycle will follow the modulation envelope.

Due to the amplification which is available in a multi-element tube, the sensitivity (Continued on page 796)

NEGATIVE FEEDBACK

PART II—Feedback to the Screen-Grid Circuit

By JOHN W. STRAEDE*

IN the previous part of this article we considered the effect of negative voltage feedback on power output and saw that the effect was slight and depended on the bias. Now we come to another type of feedback—that applied to the screen grid of a tetrode or pentode tube. The results are very different.

If we examine the circuit and characteristics of a 6V6G or 48 etc. connected as a "triode," we find that we have really a tetrode with 100% negative voltage feedback applied to the screen. What are the results? A loss of power, a loss of gain, a

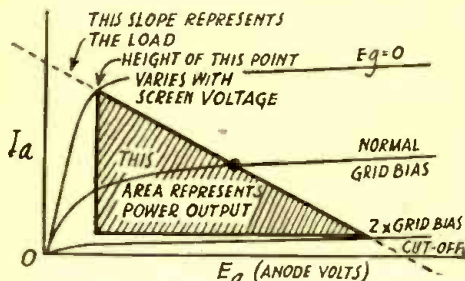

Fig. 1—Effect of screen feedback on power.

loss of efficiency and in some cases, a slight reduction in distortion. The three losses are not a good thing. In fact, triode operation of tetrodes and pentodes is of very little use except to provide triodes intermediate in size between the 6J5 and 2A3.

Instead of using negative feedback, suppose we use positive feedback. The reverse happens: An increase in power (quite a large increase), a gain in efficiency, a greater gain, and a rise in distortion. Bad luck the last, but we can compensate for that by the usual negative feedback to control grid.

Let us find out why feedback to screen affects the power (see Fig. 1). There are two limits to the swing along the load line. One limit is set by "cut-off," the other by grid current (or by limit of grid power and limit of positive grid voltage in case of AB₂ and B₂ operation). The screen voltage affects this second limit. The power output is proportional to the product of the change in plate voltage and the change in plate current, and therefore the power is shown graphically by the triangular shaded area in Fig. 1. Applying feedback to the screen does not necessarily change the voltage swing (the base of the triangle), but

*Lecturer in Electro-Acoustics, Melbourne Technical College, Australia.

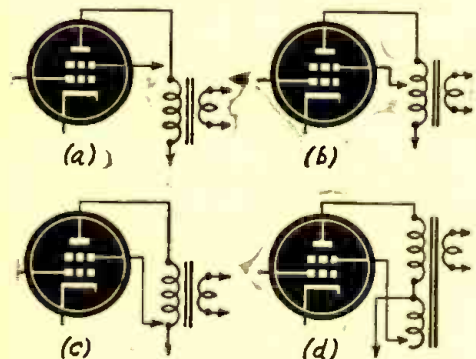

Fig. 2—Evolving a positive feedback circuit.

it does alter the current swing (or height) providing of course that the load is changed to suit.

The more positive the screen the greater the possible current swing of the plate (compare 6V6 graphs for E_{g2} = 250 and E_{g2} = 285 for an example).

The converse is also true. The control grid and plate are antiphase—when the grid goes as positive as possible the plate goes as negative as possible and at this time the maximum plate current is required. If negative feedback-to-screen is used, then the screen is made less positive (which is the same thing as more negative) and the maximum plate current is reduced, so we get a smaller current swing and smaller power. This assumes that the load is suitably adjusted; if not, then there is an even greater reduction in power.

POSITIVE SCREEN FEEDBACK

Suppose we use positive feedback to screen. At the E_{g1} = 0 end of the swing, the plate is least positive so the screen is now most positive, more positive than the applied voltage in fact, resulting in a greater plate current and greater power output, though not a very great increase in distortion and no rise in grid current distortion as regards the control grid. Fig. 2 shows the evolution of a positive-feedback circuit.

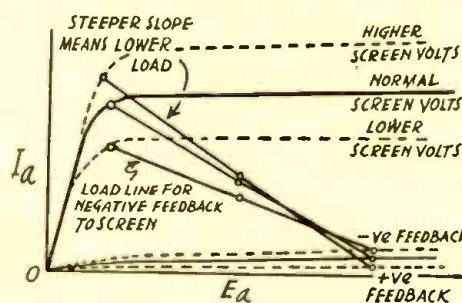

Fig. 3—Effects of feedback to screen grid.

This looks like an easy way to increased power without increased cost. There are snags, though not very terrible ones. First of all, there is a rise in screen dissipation, though this rise occurs only on loud signals and the no-signal dissipation is not increased.

Second, the maximum cathode-to-screen and plate-to-screen voltages are increased, but the increases are not likely to harm the tube in any way.

Third, positive feedback is apt to be a bit tricky, although the simultaneous application of negative feedback (but not to the screen!) will help to eliminate instability.

Fourth, the screen takes power from the plate circuit, thereby reducing the output power a little. However, this drain helps to compensate for varying load impedance!

Fifth, a tapped output transformer is nearly always required.

The effects of feedback to screen are shown in Fig. 3.

Let us take a practical case and calculate the values. Suppose the circuit is that of Fig. 4 and the output tube is a 42 with plate

and screen supply voltages of 250. Normally the output would be just under 2.7 watts with a load of 7000 ohms if the output is a pure sine wave. (The usable output is a little over 3 watts.)

First let us see what the maximum permissible feedback is. Our formula for gain has now become

$$\beta = \frac{m}{M} = \frac{1}{1 - Ma}$$

where β = ratio of gain with feedback to gain without feedback

M = gain (in this case from screen to plate) without feedback and a = fraction of voltage fed back.

If the product Ma is equal to, or greater than 1, then β becomes infinity, i.e., the

circuit is unstable, so a is limited to $\frac{1}{M}$

(in practice to about $\frac{3}{4}$ this value). With a load of 6000 ohms, M is approximately 3 so a can be .25 (for example).

Now when E_g becomes zero the plate swings from 250 volts to about 50 volts, a change of 200 volts, and the screen voltage rises from 250 to 300 volts. The plate characteristics are momentarily modified allowing the current to rise to 85 Ma at 45 volts. Total plate swing is from 30 volts 74 Ma to 425 volts 7 Ma giving a power

output of approximately $\frac{(425-30) \times (74-7)}{8}$

milliwatts, approximately $3\frac{1}{2}$ watts. Actually the usable output is now about 4

watts in place of less than $3\frac{1}{2}$. The load resistance is given by $\frac{425-30}{74-7}$ Kilohms or

5890 ohms, not much less than our preliminary "guess" of 6000 ohms, and to be quite rigorous we should repeat our calculations. However, the error is small. The necessary grid bias is obtained from the 250 volt characteristics and is found to be -16.5 volts.

Enough negative feedback should be employed to counteract the gain and dis-

ortion due to the positive feedback. As the increase in gain is given by

$\beta = \frac{1}{1 - Ma} = \frac{1}{1 - 3 \times \frac{1}{4}} = 4$

the amount of negative feedback should be at least sufficient to cause a reduction of gain of $\frac{1}{4}$ (or 12 db). This can easily be obtained by connecting the 42 plate to the plate of the preceding tube by means of a suitable resistor (see Part One for calculations). The value of the resistor is not critical, except that it must not be too big.

(Continued on page 810)

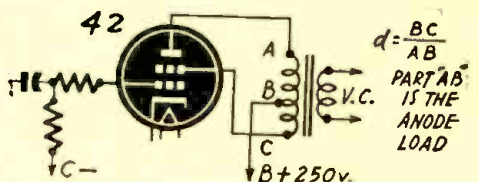

Fig. 4—Practical case of positive feedback.

Simple Multitester For Volts and Ohms

By HOMER L. DAVIDSON

THE beginner in radio today has a very slim chance to procure a volt-ohmmeter of any sort. Even the average serviceman finds that he has an acute shortage of meters for his critical work. I made a small voltmeter from an old 1.5-ampere R.F. ammeter that was originally used for antenna current measurements and R.F. ampere readings.

By searching through the junk pile you can usually run across one of these meters. A ham radio station or a second-hand electrical parts store might have one laying around that can be bought for a few dollars. After the meter has been obtained, it can be easily converted into a pocket volt-ohmmeter.

The type of meter used by the author was a two-inch Weston Thermocouple R.F. ammeter, model 507. It was originally used to measure antenna current. This meter will measure voltages up to 250 volts. With two small flashlight batteries, you can measure low ohms from zero up to 125 ohms, which is better than the average pocket ohmmeter. This scale can be used to measure the resistance of small R.F. and I.F. coil windings. With this low-ohm scale, the taps on power transformers, output transformers, tube filament resistance and pilot light filament resistances can also be measured. Caution must be observed on these measurements as you are placing the resistance of the meter directly across the battery terminals. The tests should be made quickly and the test leads should never be permitted to remain in the low-ohm jacks. A small D.P.D.T. toggle switch is thrown to short out the high-ohm and common terminal as shown in Fig. 1. If you don't have room enough for the toggle switch on the surface of the front panel, it can be mounted on the top or side panels of the meter box.

The voltage range can be extended according to the voltage-dropping resistor placed in series with the meter. For high voltages up to 200 volts a 50,000-ohm fixed carbon resistor was used. On the low-voltage scale, the correct terminals are L.V. and H.O., with the S.P.S.T. switch in the ON position. The range is 0 to 3.5 volts full scale.

METER INTERNAL CONSTRUCTION

The Weston R.F. ammeter thermocouple is composed of two small ribbon type copper pieces about one inch long. The two

ends are fastened together by the pressure of two bakelite strips. At the center, the copper pieces are joined with two constantin wires or similar thermocouple material.

You must be exceedingly careful in removing the thermocouple unit from the meter assembly. First withdraw the scale, which is held with two screws to the frame. A jeweler's screwdriver is useful for this. Then loosen the two screws inside the thermocouple assembly. The two copper pieces will now slip out. Cut the two constantin wires from the meter terminals and the small R.F. meter is now converted into a D.C. ammeter.

To eliminate the necessity of constructing another dial scale, the readings can be taken according to the actual readings on the present scale and compared to the chart as shown in Fig. 2. This chart can be mounted on one side of the pocket volt-ohmmeter. These readings are indirect but



A back view of the low-high volt-ohmmeter.

accurate. If the constructor desires to fashion his own scale, it can be made of white Bristol board outlined with black waterproof India ink. Three scales should be made, for the low-ohm, high-ohm and voltage readings. Of course, if you are fortunate enough to own a D.C. ammeter, you are just that much ahead of the game.

The high-voltage jack has a 50,000-ohm fixed resistor in series with it and the meter, for the extended high-voltage range. If you desire to further increase this range, another current limiting resistor is required. To measure unknown voltages the high-voltage jacks should be employed first, to prevent damage to the meter.

On the low-voltage scale, the terminals L.V. and Common are used. This range will measure up to 3.5 volts D.C., by varying the

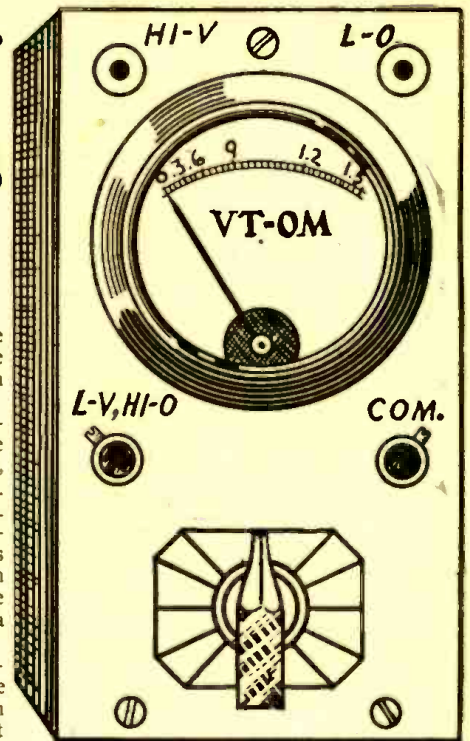

Front panel layout with position of pin-jacks.

10,000-ohm resistor to obtain full scale readings. Extreme care should again be exercised when measuring unknown small voltages. Be sure the variable resistor is at the maximum position. The D.P.D.T. toggle switch is placed in the OFF position for all voltage measurements. A DEAD SHORT WOULD RESULT IF NOT IN THIS POSITION. The two bottom jacks marked H.O., L.V. and COM are the correct high-ohm terminals.

Although this meter doesn't read to a very high value of resistance, it does have a great advantage on the low-ohm scales. The high-ohm scale will measure up to 50,000 ohms accurately. Over a large part of its range the scale is quite linear and accurate for low ohms. The D.P.D.T. toggle switch is in the OFF position for high-ohm readings.

On the low-ohm scale, the terminals are L.O. and the COM. In all instances, this is the only case in which the switch is used in its ON position. The 10,000-ohm resistor is zeroed again at 1.5 ampere, or full scale. Again, extreme care should be exercised because the resistance to be measured is placed directly across the 3-volt battery terminals.

PANEL CONSTRUCTION

The front panel was made from smooth surfaced brown masonite. This material is very easy to work with and has an attrac-

Amp reading	Ohms	Voltage	Hi Ohms
.1	5	20	50,000
.3	10	50	25,000
.5	22	60	15,000
.9	45	75	9,000
1.	50	85	5,000
1.2	90	100	1,000
1.5	100	150	450

Fig. 2—Equivalent Chart

tive finish. A circle cutter was used to cut the large two-inch hole for mounting the meter. Around the edge of this hole three small 1/8-inch holes are drilled for the (Continued on page 810)

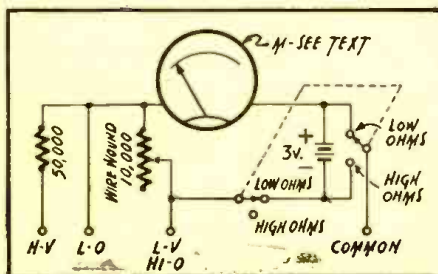

Fig. 1—The instrument is simple to hook up.

SPRAGUE TRADING POST

A FREE Buy-Exchange-Sell Service for Radio Men



OVER 8000 TRADING POST ADS!

Over 8,000 individual advertisements have been handled free of charge in The Sprague Trading Post for members of the Radio profession! Convincing evidence that this unique service is still going strong is supplied by the above photo. Here Sales Manager Harry Kalker (center) assisted by Research Engineer Leon Podolsky and Secretary Mrs. G. I. Denoyan give personal attention to a day's accumulation of Trading Post correspondence.

WANTED—Supreme 599 tube and set tester also other radio parts. Edward Howell, Route 2, Dillon, S. C.

URGENTLY NEEDED—Diagram of Approved Technical Apparatus No. 600 all ware sig. gen. Have 6116 or 6AC7 tube to trade. Hyman L. Heisler, 1372 Franklin Ave., Bronx 56, N. Y.

FOR SALE—5 and 8" dynamic speakers and four tubes. Want test instruments. Bill Gordon, Box 42, Oxbow, Sask., Canada.

WANTED—Good, usable tube tester. Will pay cash and shipping expenses. Julio Bellier Arroyo, % Pan American Airways, San Juan, Puerto Rico.

FOR SALE—205 radio tubes to sell as one lot. Includes 25Z6, 35L6, 12SK7, 12SQ7, 35Z5, also 1v; 6r; 12v; 25v; 35v tubes. Frank's Radio, 1579 Mill, Lincoln Park 25, Mich.

FOR SALE OR TRADE—Ghirardelli's Radio Physics Course and Modern Radio Servicing; "Horton's Elements of Radio"; Meyer & Westre's "Radio Construction & Repairing"; and 8th edition of "Radio Handbook." What have you? David Friedman, 1759 W. 7th St., Brooklyn 23, N. Y.

FOR SALE—1942 Chevrolet radio with suppressors, aerial and remote control head \$55. Detroit 4-D-1, \$12.75; Astatic D104HS miko \$45; and used tubes. Milo G. Hurston, 808 River Street, Alpena, Mich.

FOR SALE—Ten RCA 25-watt outdoor speakers, singly or in lot \$40 ea. Want F.M. tuners. Carl Wolf, 2227 W. Iowa St., Evansville 12, Ind.

WANTED—Good V-O or V-O-M; tubes and tube tester. Robert Gullinger, 537 North Union, Shawnee, Okla.

WANTED—18" speaker. Give details. R. A. Krutz, Command & Staff Section, AAFSAT, Orlando, Fla.

FOR SALE—Hallerafters 8-21 receiver; Thordarson P.A. system and mobile transmitter. T. Clarke, 609 Birch St., Fall River, Mass.

WANTED—2,000v, 500 ma transformer. Cash or will trade D104 miko, f4.5 Kodak camera. C. Borysowich, U.S.P.O., F., New York 16, N. Y.

WILL TRADE—Hallerafters receiver SX21 with 12" speaker. Want tube and set tester or sig. gen. What have you? Daly City Radio & Appliance Co. 7108 Mission St., Daly City, Calif.

FOR SALE—Thordarson Power Transformer, 25 cycles at 350v, 70 mil, 24v, 9 amps, and Wright Decoder 1-w-10" speaker. C. J. Murphy, C. Mus. Bldg., No. 3, % Band, Great Lakes Naval Training Station, Great Lakes, Ill.

FOR SALE—Many new and used tubes; large speakers in perfect condition; ear-phones; Fada receiver with KU speaker; power and audio transformers; set of 5 Supreme circuit manuals; condensers; filters; resistors and other parts. E. C. Kow, 70-35 68th Ave., Middle Village, Long Island, N. Y.

FOR SALE—Shallcross .75 mex. Precision wire-wound multiplier resistor; Brush R-20 professional crystal cutter and Macy electric shaver. All perfect. Philip Rosenblatt, P. O. Box 905 Hoboken, N. J.

FOR SALE—Two each 50L6; 35Z5; 12SK7; 12SA7, and 12SR7 tubes; also 12AG6 with adapters to 50L6 and 12SR7 to 35Z5. Robert DeLone, Slocane House, 34th St., New York, N. Y.

WANTED—Set of coils for Knight communication (5) Super including Broadcast coils. Frank E. Hayes, 3616 S. Marguerite Lane, Overland 14, Mo.

WILL TRADE—50L6 tubes for types 19, 117Z6GT, 25B8, 25Z5 tubes or will pay cash. B. F. Headrick, 1706 Benlok Ave., Pueblo, Colo.

SELL OR TRADE—New Worner No. 602 Electric eye. Want good tube tester and rectifier tubes. R. C. Wilmarth, P. O. Box 368, La Mesa, Calif.

URGENTLY NEEDED—Converter motor 110v, 50 cy. a-o gen. 110v 60 cy. a-o gen. output 500 watts. Walter E. Williams, 111 Corinthian Wk. Long Beach 3, Calif.

FOR SALE—Weston Thermo-galvanometer No. 425; Weston voltmeter No. 301. Want Philco or G-E record player. Frederick H. Perau, 16 Tracy Ave., Batavia, N. Y.

FOR SALE OR TRADE—Sprague deluxe Tel-Omike in original carton. Want 1A7, 1N5, 1H5, 35L6, 35Z5, 50L6, 117Z6 and 12v group tubes as payment. M. G. Dozier, 1208 College Ave., Tifton, Ga.

WANTED—Portable radio with or without tubes or batteries. Have tubular condensers, resistors, tubes and speaker to trade. John Stuhl, 61 Evelyn Place, Rosebank, Staten Island 5, N. Y.

WANTED—Philco sig. gen. and vacuum tube voltmeter. William E. Ward, Box 204, R.F.D. No. 2, New Bedford, Mass.

WILL TRADE—Jackson 660 dynamic signal analyzer. Want Hickok No. 49228 V-O-M, Gulf Radio Service, 16 W. Beach Drive, Panama City, Fla.

FOR SALE OR TRADE—Metal cabinet, ACN dial, new & used tubes, xmitting chokes, condensers, receiver transformers, sockets, coils and rolls razor. Want cash or microscope equipment and books. B. A. Williams, 109 1/2 E. State St., Redlands, Calif.

WANTED—35L6, 584, 5Y3, 35Z5 and 50L6 tubes. Cash or will trade dual analyst and signal tracer ac-dc. J. J. Flynn, 1338 Knollwood, Lansing Co., Mich.

FOR SALE—Sprayberry course with instructions on use of oscilloscopes and signal tracing, \$20, or will trade for small radio or what have you? S. Bizek, 1421 Venoy Road, Wayne, Mich.

FOR SALE—100-watt phono xmitter; 2—RCA 838's; six tracer; V.T.V.M.; motor and push-button attachment for auto radio. Also back issues of Radio & Television. Leroy Ellis, 303 N. 13th St., Richmond, Indiana.

WILL TRADE—Several speakers, coils, other equipment and accessories, resistors, condensers, etc. Want test equipment and tubes. Luther Harbin, Mesquite, Texas.

FOR SALE—Universal velocity microphone with chrome & black 6" table stand; 14' rubber shielded cord with phone plug. Parky Boone, 18 Iberia St., St. Augustine, Fla.

WANTED—6v 115v P.A. 30; and one 60 or 75 watt. Send full information. Neilson Radio Shop, Sidney, Iowa.

FOR SALE—Hickok Electron tube tester with directions \$30. Want output meter, Rider chanalyst and hard-to-get radio tubes. Charline Rucker, Saratoga, Iowa.

SELL OR TRADE—Precision analyzer and a-c meter calibrated in M.F.D. for capacity measurements. \$25. Want good portable radio or what have you? S. Bizek, 1424 Venoy Road, Wayne, Mich.

URGENTLY NEEDED—Sig. gen.; V-O-M; tube checker; and 1A7, 1H5, 6A7, 12SA7, 12A7, 12A8, 25, 35, 50, 70, 117 series tubes. Cpl. H. Bronwell, 1013 Montana, El Paso, Texas.

FOR SALE—2 speed, 12" G-E turntable with Astatic B10 pickup mounted. Also RCA Jr. crystal pickup. L. M. Mungler, DeKalb, Ill.

WANTED—3" scope; six gen. with mod. V.T.V.M. and late model tube tester. Everett S. Davis, Dave's Flit Shop, Taos, New Mexico.

FOR SALE—2 Lifetime 4' trumpets with units; 2 Masonite 4' trumpets with W.E. 555 units; Bacon driver unit; exciter units; D42 Lifetime mike and portable mike stand. George M. Handy, Norwich, N. Y.

WANTED—Any make and size small radios. State prices. Sunnyside Radio Shack, Burlington, N. J.

SELL OR TRADE—Hard-to-get new tubes in original cartons. State wants and what you will trade. E. Thompson, 26 Arverne Terrace, Irvington, N. J.

WANTED—25Z5, 25Z6, 117Z6, 50Y6, 35A5, 35L6, 35Z4, 35Z5, 45Z5, 5Y3 tubes or what have you. Rodney's Radio, Burlington, N. J.

FOR SALE OR TRADE—Radiotone over-head recorder, 90 and 112 lines. High fidelity magnetic cutting head less motor and turntable. Want phono equipment. Walter B. Ford, 1410 Cedaredge Ave., Los Angeles 41, Calif.

FOR SALE—Used Weston No. 425 and No. 301 meters in good condition. C. H. Allison, 153 E. Elizabeth, Rm. No. 563, Detroit, Mich.

FOR SALE—2 Elmac 100 TT transmitter tubes; 2 RCA No. 866 tubes and sockets. Also misc. condensers and resistors. T. A. Trowbridge, N. 5207 Post St., Spokane 13, Wash.

SELL OR TRADE—Westinghouse electric dynamotor 27 1/2" input, 350v, output \$5 or trade for 16mm. wound film subject. Herbert Hedstrom, 33 Granite St., Foxboro, Mass.

FOR SALE—New 30-watt amplifier; metal tubes; radio with built in phono pickup; 18" x 24" metal case; monitor speakers and inverter for 6v. D.C. and 110v. A.C. use. Blount's Radios and Amplifiers, 2673 Harrison St., Gary, Ind.

YOUR OWN AD RUN FREE!

Sprague will gladly run your own ad free of charge in the first available issue of one of the six radio magazines in which The Trading Post appears. WRITE CAREFULLY or print, hold it to 40 words OR LESS, and confine it to radio subjects. Sprague, of course, reserves the right to rewrite ads as necessary, or to reject those which do not fit in with the spirit of this service.

HARRY KALKER, Sales Manager

Dept. RC-95, SPRAGUE PRODUCTS CO., North Adams, Mass.

Jobbing Distributing Organization of Products of the Sprague Electric Co.



SPRAGUE CONDENSERS

KOOLOHM RESISTORS

T.M. REGISTERED U. S. PATENT OFFICE

Obviously, Sprague cannot assume any responsibility, or guarantee goods, services, etc., which might be exchanged through the above advertisements.



...here's a
TIP
for You!

In fact there are four interchangeable tips adapted to the Ungar Soldering pencil... each designed to do speedy precision work on hard-to-reach jobs!

No. 537 Pencil Tip, made from Elkaloy A, Tip 1/8" dia.

Ruggedly built, the Ungar Soldering tool weighs only 3.6 ozs., is perfectly balanced and handles like a fountain pen. Heats in 90 seconds. Draws only 17 watts. Unit complete with any one tip sells at less than \$2. Please order from your Electronics distributor.

No. 538 Chisel Tip, made from Elkaloy A, Tip 1/8" dia.

No. 536 Standard Tip, made from Hard Drawn Copper

No. 539 Extra Hot, made from Tellurium

Ungar
Electric Tools, Inc.
Formerly Harry A. Ungar, Inc.
LOS ANGELES 54, CALIF.

RESEARCH BOARD URGED

ESTABLISHMENT of a National Research Foundation by Congress for the purpose of promoting a national policy for scientific research and scientific education was proposed by Dr. Vannevar Bush, director of the Office of Scientific Research and Development, in a report submitted last month to the White House. The report is titled "Science—The Endless Frontier."

Prepared at the request last November of President Roosevelt, the report recommended:

1—That the Foundation be formed to develop scientific research, financially support basic research in non-profit organizations, encourage scientific talent in American youth by offering scholarships and fellowships and promote long-range research on military matters.

2—That the Foundation consist of nine members to be selected by the President and be responsible to him. They shall serve four years and without compensation.

3—That the Foundation have the following five divisions: Medical Research, Natural Sciences, National Defense, Scientific Personnel and Education, and Publications and Scientific Collaboration.

Dr. Bush said that an adequate program for Federal financial support of basic research and scientific education, as proposed in his report, would cost about \$33,000,000 at the outset and might rise gradually.

The report recommended a program to provide 24,000 undergraduate scholarships and 900 graduate fellowships, which would cost the Government about \$30,000,000 annually when in full operation. Each year under this program 6,000 undergraduate scholarships would be made available to high school graduates, and 300 fellowships would be extended to college graduates. Those who receive such scholarships and fellowships would constitute a National Science Reserve and would be subject to call into Government service in connection with scientific or technical work in time of war or other national emergency.

Release of war-developed scientific knowledge at the earliest possible date was also strongly urged in the report.

One-fifth of the families of Kansas plan to buy a new radio at the earliest moment one can be obtained, a survey by Dr. F. L. Whan, of the University of Wichita, shows. More than one-quarter of them already have the funds in hand to buy their new radios.

\$3.00 FOR YOUR CARTOON IDEAS

RADIO-CRAFT, as you will have noticed, prints a number of radio cartoons, which we intend to keep on publishing every month indefinitely. We invite our readers to contribute to this feature by sending in their ideas of humorous radio ideas which can be used in cartoon form. It is not necessary that you draw a sketch, but you may do so if you so desire.

RADIO-CRAFT will pay \$3.00 for each original idea submitted and accepted.

We cannot return ideas to this department nor can we enter into correspondence in connection with them. Checks are payable on publication.

Address all entries to RADIO CARTOONS, c/o RADIO-CRAFT, 25 West Broadway, New York 7, N. Y.

HOW TO TEST A RADIO IN 2 MINUTES OR LESS!

Want to repair radios for neighbors and friends? Or, if you are a radio serviceman, do you want to learn how to diagnose radio troubles and fix sets TWICE AS FAST and TWICE AS PROFITABLY—without a lot of costly, hard-to-get test equipment?

Of course you do—and Ghirardi's RADIO TROUBLESHOOTER'S HANDBOOK is just the book that will make it possible for you to do it—for a total cost of only \$5. Send coupon on opposite page.

"IT'S THE BEST OUT OF 20" SAYS CHIEF ENGINEER

F. S. Bailey, Chief Engineer, Radio Operator's School, Brownsville, Texas, gives this endorsement of Radio-Electronics greatest basic training book: "We find Ghirardi's RADIO PHYSICS COURSE the best of 20 or more books we have tried... both as a complete course in Radio Physics and for all other branches including broadcasting. It is giving our students the VERY BEST FOR THEIR MONEY." Order now—use coupon on opposite page!

HOW MUCH Should Good Radio-Electronic Training Cost?

The answer is that the best basic Radio-Electronic Training that money can buy NEED NOT COST YOU MORE THAN \$5 complete. Ghirardi's RADIO PHYSICS COURSE BOOK (see advertisement on opposite page) is as complete as any book or course AT ANY PRICE—and far more complete than most. It is much easier to learn from—and it is the basic training most widely endorsed by radio experts themselves. Money-back guarantee. You cannot lose! Send coupon TODAY!

The Background of

ELECTRICAL SCIENCE

JUST OUT!



THE SOUL OF AMBER, a sparkling new book by Alfred Still, will provide hours of pleasurable reading—and acquaint you fully with the entire brilliant history of Electricity in human terms. The "Soul" of amber is, of course, Electricity, and this fascinating

book follows its development from its earliest beginning associated with the superstitions of fire dancers. A. A. Ghirardi says... "It is the liveliest, most fascinating and informative story of Electricity I have ever read." 274 pages. Price \$2.50. See coupon on opposite page.

MAKE MONEY REPAIRING RADIOS AND OTHER ELECTRONIC EQUIPMENT

GHIRARDI TELLS YOU EXACTLY *WHAT* TO DO ... EXACTLY *HOW* TO DO IT

If you like to repair radios at home in spare time, Ghirardi's RADIO TROUBLESHOOTER'S HANDBOOK offers you a new, fast way that makes the work easy—without a lot of previous experience or scarce, expensive test equipment. Or, if you are a professional radio man, it helps you repair two sets in less than the time you'd normally take for one. It is the ideal book for training new helpers, for substituting tubes and parts in these days of shortages, for repairing cheap sets quickly and profitably—in short, for repairing radios better, faster and more profitably than you may have thought possible.

4 LBS. OF FACTUAL, TIME-SAVING, MONEY-MAKING SERVICE DATA

RADIO TROUBLESHOOTER'S HANDBOOK isn't a "study" book. It rolls up its sleeves and goes to work for you the minute you get it. It can easily pay for itself the first time you use it! Simply look up the make, model, and the trouble symptom of the Radio you want to repair . . . and go to work. No useless testing! No lost time or motion! The HANDBOOK'S clear instructions tell you exactly what the trouble is likely to be . . . and EXACTLY how to fix it. Actually, this

big, 4 pound, 744-page, manual-size HANDBOOK brings you factual repair data for practically every radio in use today—over 4,800 individual makes and models!

In addition, there are hundreds of pages of helpful repair charts, tube charts, data on tuning alignment, transformer troubles, tube and parts substitutions, color codes, etc.—all for only \$5 (\$5.50 foreign) on an ABSOLUTE 6-DAY MONEY-BACK GUARANTEE.

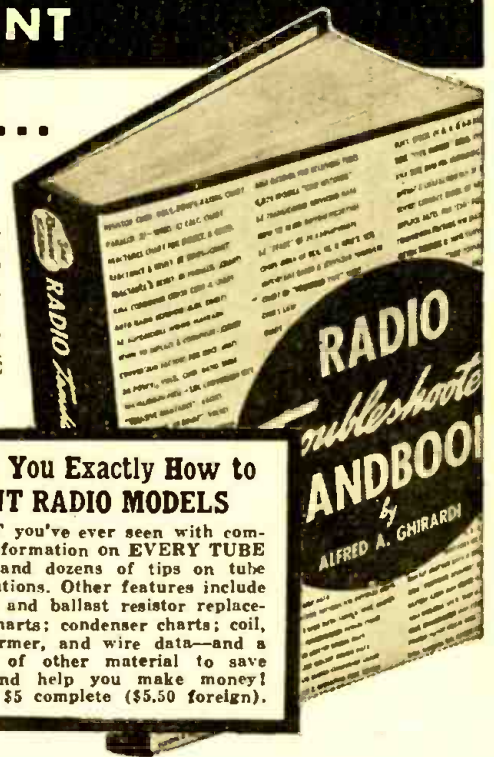

This "Automatic Teacher" Shows You Exactly How to REPAIR OVER 4,800 DIFFERENT RADIO MODELS

Over 400 pages of the RADIO TROUBLESHOOTER'S HANDBOOK include specific common Trouble Symptoms, their causes and Remedies for practically every Radio Receiver in use today. IN ADDITION, there are hundreds of pages including i-f alignment peaks for over 20,000 superhets; a big data section on i-f transformer troubles—and the most up-to-the-minute TUBE

CHART you've ever seen with complete information on EVERY TUBE TYPE and dozens of tips on tube substitutions. Other features include plug-in and ballast resistor replacement charts; condenser charts; coil, transformer, and wire data—and a wealth of other material to save time and help you make money! ONLY \$5 complete (\$5.50 foreign).

COMPLETE BASIC RADIO-ELECTRONIC TRAINING

FOR BEGINNERS \$ **5**

All the Basic Science of Radio-Electronics in One Big 3½ lb. Book—No Monthly lessons to Wait for

(\$5.50 foreign)

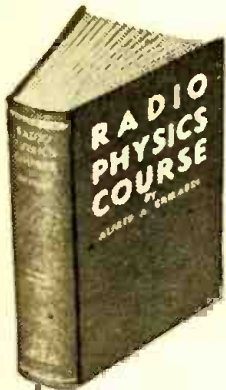

36 COURSES IN ONE

Easily worth \$50 or more if broken into "course" form and sent to you in monthly lessons.

Train NOW for the most interesting of all post-war futures—RADIO-ELECTRONICS! Ghirardi's 972-page RADIO PHYSICS COURSE BOOK gives you all the basic training you need—at a price you can afford to pay! Actually, this big book has started more people in Radio-Electronics than any other book or course. It is more widely used for home study—and more widely used in U. S. Signal Corps and Navy Schools and in civilian schools and colleges than any other book of its kind.

NO OTHER COURSE LIKE IT!

Ghirardi's RADIO PHYSICS COURSE book with its 500 illustrations and 856 self-testing review questions makes it surprisingly easy for you to learn at home without an instructor. Nothing is omitted, nothing condensed. Everything is made as easy as A-B-C. Ask any radio man! You'll be amazed how quickly you'll master the subjects that other courses and books make seem very complicated. Begin today! Examine this truly great book for 5 full days—and get every cent of your money back if not more than satisfied. You cannot lose!



EVERY CONCEIVABLE SERVICE SUBJECT

Explains circuit and operation of all types of essential service instrument types; How and When to use them; How to build your own; Preliminary trouble checks; Troubleshooting; Repairs; Obscure radio troubles; Aligning and neutralizing; Auto and Marine Radios; Interference reduction; AVC and QAVC circuits, etc., etc.

LEARN PROFESSIONAL RADIO SERVICE WORK

at home without an instructor!

Study now for a good job as a professional Radio-Electronic Service Expert. It's easy to learn from Ghirardi's big 1300-page profusely illustrated MODERN RADIO SERVICING book that costs you only \$5 complete. This one big book covers all phases of the work! Explains all necessary test instruments . . . even how to build your own if you prefer; how to troubleshoot all makes of radios, analyze electronic circuits, test components, make adjustments, repairs, etc., etc.—all step-by-step. Even explains how to start a successful Radio-Electronic Service Business of your own. Sold separately for \$5 (\$5.50 foreign), or, see MONEY-SAVING COMBINATION OFFER in coupon.

5-DAY MONEY BACK GUARANTEE

Technical Division, MURRAY HILL BOOKS, Inc., Dept. RC-95, 232 Madison Ave., New York 16, N. Y.

Enclosed find \$..... for books checked; or send C.O.D. (in U.S.A. only) for this amount plus postage. If not fully satisfactory, I may return the books at the end of five days and receive my money back.

- RADIO TROUBLESHOOTER'S HANDBOOK \$5 (\$5.50 foreign)
- MODERN RADIO SERVICING \$5 (\$5.50 foreign)
- RADIO PHYSICS COURSE \$5 (\$5.50 foreign)

- Special MONEY-SAVING COMBINATION: Both Modern Radio Servicing and Troubleshooter's Handbook. \$9.50 for the two (\$10.50 foreign)
- THE SOUL OF AMBER \$2.50 (\$2.75 foreign) (See opposite page)

Name

Address

City & Dist. No. State

(Please Print or write plainly)

"LOUD" CRYSTAL RADIO

By JOSEPH DANTE AMOROSE

I AM a crystal set enthusiast. For 25 years I experimented with every available crystal set circuit and crystal set component. There is hardly a size, shape, or form of condenser, coil, antenna, ground or crystal detector that I have not tried in all those years.

As a result of this experience I have come up with a set that really "does well." It is LOUD—louder than any set I have tried in 25 years. It is a set anyone can build. All that is necessary is application of sound radio principles, use of good, low-loss parts and employment of a well-designed crystal set circuit, plus a small amount of diligence and care in constructing.

In this day of scarce electric radios, that should provide something of value; a radio set that stays constantly on the job is a real asset these days. With these thoughts in mind, I append the following details:

For aerial "A," use at least 150 feet of No. 14 gauge, single or stranded wire. Erect it 40 feet high. A noticeable "gain" was noted when 500 feet of wire was used. Put this up in five 100 foot lengths; use a single lead-in.

A loading coil "B" must be used. This adds volume, improves selectivity and also increases the receiving range by raising the wave-length characteristic of the set. A Bakelite form, 3 inches in diameter, about 3 inches long is best. On this form wind

60 turns of No. 24 DCC wire. Tap every 5 turns for best volume and selectivity.

Instead of two single-section condensers, a 2-Gang condenser "C" is used. This has certain advantages. First, it gives us one-dial tuning. But more important, the "cross-connecting" of the two circuits (primary and secondary) gives us both inductive and conductive transfer of signal energy.

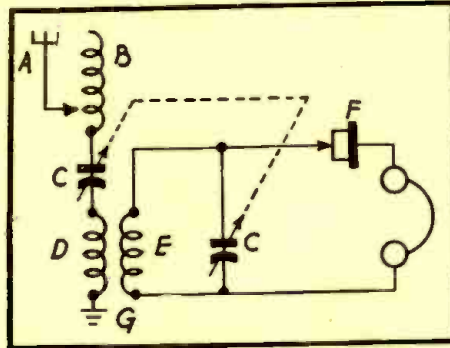

The net result of this coupling is a noticeable boost in volume and sensitivity. Moreover, one 2-gang condenser is cheaper than two single ones, and they are more readily available—single condensers have

all but disappeared from the market. Any of these three values may be used—350 mmf, 410 mmf, or 450 mmf. Specifically, the lower the wave length of the station in your vicinity, the lower should be the value used.

The coupler coil, "D," is also 3 inches long, of 3-inch diameter Bakelite, wound with 15 turns of No. 24 DCC on the primary and 90 turns on the secondary "E." The 15- and 90-turn windings should be separated by 1/8 inch of space.

A large variety of crystals, "F," were tried. The loudest of them all was the Steel Galena. It brought in the most distant stations with the greatest volume. In sections where many local stations abound, it is suggested that a good Iron Pyrites crystal be used. This is a little more selective than Galena—does not tune so "broad."

A switching arrangement can be used to throw either crystal in circuit. Carborundums work well too, but the capacities are a bit too high for best operation. For loudest volume and best operation all around, the Galena is recommended.

The importance of a good ground "G" cannot be too strongly stressed. In rural areas the pipe leading to the well makes the best possible ground. In cities, the water supply pipes are best—better than steam pipes. Do not use gaspipes for grounds! One ground works well; but five are better. And ten aren't too many. In test, a noticeable increase in volume and sensitivity was noted when multiple grounds were used. Plant extra grounds in wet earth, at least six feet deep and separate widely.

A word about headphones. USE THE BEST YOU CAN AFFORD. A good set is worthless with poor phones. Choose a set with at least 2,000 ohms resistance, and of a well-known, high-quality make.

If you live near enough to a station to operate a speaker, choose one that has an impedance of at least 10,000 ohms. Some magnetic type speakers give splendid performance; be sure no output transformer is required with the magnetic speaker you buy.

For loudest volume, however, the old horn-type speakers used with battery sets are best. Select one with a movable-armature unit. The larger the horn, and the more exponential the curve, the louder will be the volume—the shape of the horn is important.

A few notes for experimenters: Use a fixed crystal in the circuit, when carrying on experiments. When your volume remains constant, it is easier to detect a slight increase in volume this way, than it would be if you used an adjustable type detector. This is the method always used by the author. It quickly tells you whether the change you have made in the set improved its performance or not—an adjustable detector on a "hotter" spot can fool you.

For those locations where numerous local stations abound, the set described can be made more selective by using a wave trap between the Loading Coil and the stator of the condenser in the primary section. (The wave trap may also be added in other sections—experiment will show best location.)

Finally, let it be understood this is not a miracle set by any means. It is just a darn good set; and it has provided the author with many a year of loud, clear, trouble-free and headphone-free reception.

ADAPTER FOR THE V.T.V.M.

(Continued from page 773)

potentiometer until this meter reads twice the voltage the 20,000-ohms-per-volt meter is set to. Example, 20 ohms/volt meter is on 2.5-volt range, set potentiometer for 5-volt reading on standard meter. Connect the V.T.V.M. to the potentiometer as shown in Fig. 3. Adjust the calibrating potentiometer in the vacuum-tube voltmeter until the V.T.V.M. reads full scale. Disconnect the V.T.V.M. and adjust its zero adjustment to get the meter to return to zero. Again reconnect the V.T.V.M. and adjust the calibration potentiometer for full-scale reading. Go over these two adjustments as many times as necessary until the meter will read zero with no voltage applied and full scale when connected to the voltage source.

The calibration will now be complete for all ranges and R-9 should require no further adjustment unless a tube is replaced.

To use the V.T.V.M. connect the ground lead to the chassis of the radio set under test (B-minus on A.C.-D.C. sets) and the probe to the voltage being measured. If the meter reads backward reverse the meter switch, S-3.

MEASURING RESISTANCE

To read high resistance throw the Ohms-volts switch and the meter-range switch to Ohms. Connect the lead from the Ohms jack to the voltmeter probe. Adjust the "Ohms Zero Adjustment" for full scale reading (zero ohms). Connect the resistance to be measured between these two leads. Caution: Never leave the ohms-volts switch on ohms when not using the ohmmeter or the battery will discharge.

The great advantage of a V.T.V.M. is that one can connect the probe to the grid of a tube without materially affecting its operation. To prove this tune in a station on a radio and connect the meter probe to one of the I.F. amplifier grids. Read the A.V.C. voltage and try tuning the radio through the station to see how this voltage varies. Connect the probe to the oscillator grid and read the voltage there. This will slightly detune the radio. How much detuning takes place can be determined by noticing how much the dial must be moved to bring the station in clearly again.

Using a voltmeter of this type for a short while will convince anyone that: "Where voltages are to be measured in a radio receiver a vacuum tube voltmeter will do it better."

Parts List for Fig. 2

- R1—9 meg.
- R2—900,000
- R3—90,000
- R4—10,000
- R5—10,000 ohms-zero
- R6—See text
- R7—22,000 ohms on HICKOK 133-B
- R8—30,000 for Weston 772
- R9—10,000 meter zero
- R10—10,000 calibration
- R11—5,000 10 W.
- V4—80 or 5Y3.
- V1, V2—6SN7
- V3—6H6 or 6H6-G
- S1—Range switch 4 point
- S2—S.P.S.T. Ohms-volt switch
- S3—D.P.D.T. Meter reverse switch
- S4—S.P.S.T. off-on switch
- C1—.01 600 V.
- C2—4 or 8 mfd. 450 volts
- J1—Vacuum-tube voltmeter jack
- J2, J3—Ohmmeter Jacks
- J4, J5—Jack for meter

Long Scale, Wide Range Volt-Ohm-Milliammeter



DOUBLE SENSITIVITY D.C. VOLT RANGES

0-1.25-5-25-125-500-2500 Volts, at 20,000 ohms per volt for greater accuracy on Television and other high resistance D.C. circuits.

0-2.5-10-50-250-1000-5000 Volts, at 10,000 ohms per volt.

A.C. VOLT RANGES

0-2.5-10-50-250-1000-5000 Volts, at 10,000 ohms per volt.

OHM—MEGOHMS

0-400 ohms (60 ohms center scale)
0-50,000 ohms (300 ohms center scale)

DIRECT READING OUTPUT LEVEL DECIBEL RANGES

-30 to +3, +15, +29, +43, +55, +69 DB

TEMPERATURE COMPENSATED CIRCUIT
FOR ALL CURRENT RANGES D.C. MICRO-AMPERES

0-50 Microamperes, at 250 M.V.

D.C. MILLIAMPERES

0-1-10-100-1000 Milliamperes, at 250 M.V.

D.C. AMPERES

0-10 Amperes, at 250 M.V.

OUTPUT READINGS

Condenser in series with A.C. Volts for output readings.

ATTRACTIVE COMPACT CASE

Size: 2½" x 5½". A readily portable, completely insulated, black, molded case, with strap handle. A suitable black, leather carrying case (No. 629) also available, with strap handle.

LONG 5" SCALE ARC

For greater reading accuracy on the Triplet RED DOT Lifetime Guaranteed meter.

SIMPLIFIED SWITCHING CIRCUIT

Greater Ease in changing ranges.

Write for descriptive folder giving full technical details.

HERE'S THAT NEW
TRIPLETT
625-N

Triplet

ELECTRICAL INSTRUMENT CO. BLUFFTON, OHIO

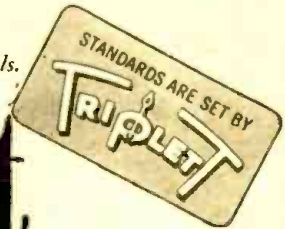

A STARTLING SUPERHET

By W. T. CONNATSER

THIS superhet is no ordinary three-tube receiver. It is based on the circuit published in the March, 1945, issue of *Radio-Craft* (New Idea in Detector Circuits). Tested alongside a ten-tube modern radio, it pulled in the same distant stations with considerably less noise. It uses an aerial about 36 feet long, which has been found to be sufficient for most purposes.

The complete schematic is shown in Fig. 1. The 6J7 has four functions in this circuit. It takes care of the I.F. amplification, detects the signal, acts as the A.F. amplifier and provides the A.V.C.

The 456 Kc. signal is applied to the grid of the 6J7, where it is amplified by the tube and appears on the plate. It passes readily through the 50-mmfd. condenser and also through the 100-mmfd. condenser to the suppressor. It is prevented from passing through to the control grid of the 32L7 by the coil-condenser combination, hooked up between the plate of the 6J7 (prong 3) and the 32L7 grid (prong 5).

The circuit is deliberately tuned to the intermediate frequency so that frequencies both above and below 456 kilocycles pass through but 456 kilocycles will not. The coil-condenser combination connected between the ground and the suppressor (prong 5 of the 6J7) through the two condensers marked 100 mmfd., and 50 mmfd., respectively, also prevents the signal from being grounded out, since this combination is tuned to 456 kilocycles. It acts as the tuned detector circuit.

The signal is rectified by the suppressor, acting as a diode, then passes through the 1 megohm resistor, back through the I.F. transformer to the grid of the same tube

where the signal is amplified greatly at audio frequency. This audio signal now passes through the 465-Kc. tuned circuit and the coupling condenser (.05 mfd.) to the grid of the 32L7. This audio signal is prevented from passing through the 20 henry choke as the 456 Kc. signal was prevented from passing through the tuned coil-condenser combination.

Automatic volume control takes place in the 100,000- and 250,000-ohm resistors in the suppressor circuit. The suppressor has a slightly negative charge on it. As the grid signals get stronger (as more voltage is placed on the grid by the incoming signal), the suppressor gets more negative, which biases the grid more negative, due to voltage drop across the 250,000-ohm re-

sistance, and tends to cut down the signal. If the grid signal were weaker there would be less negative voltage on the suppressor and it wouldn't apply as much bias to the input grid. Therefore it acts as an automatic volume control.

Regeneration is accomplished by the 500,000-ohm volume control which varies the potential of the screen grid.

The first I.F. is a factory job, as is the oscillator coil. The other coils were made by me using small trimmer condensers I had on hand. Tuning can be sharpened by substituting a 15 mmfd. condenser for the 50 mmfd. in the plate of the 6J7 to the secondary of the output I.F. transformer.

All .1 mfd. condensers shown in the diagram can be .05 instead. The .1 mfd. condensers were used only because they were

(Continued on page 814)

Fig. 1 — Three-tube superheterodyne, with the 6J7 performing a triple function. By use of a special circuit, the tube acts as I.F., A.F. and detector, also supplying the A.V.C.

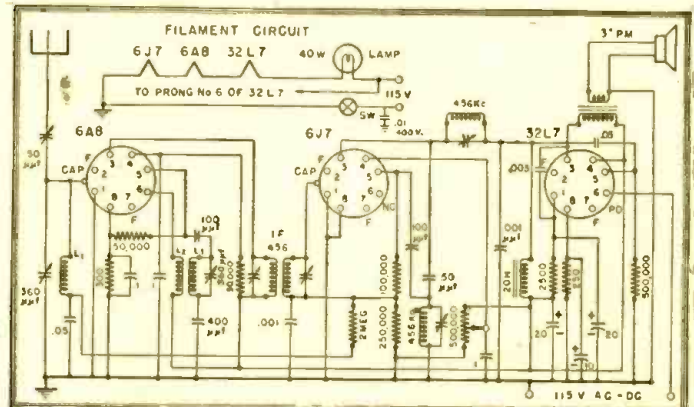

World-Wide Station List

Edited by ELMER R. FULLER

DURING the past few months, reception has been rather poor, due to the presence of many sun spots, including the largest one ever viewed. At present conditions seem to be improving, and perhaps we can get in a short period of good listening before the winter season comes on. Now is the best time in the early evening for the high frequencies, and many good results are being reported here. Among these are the BBC on several frequencies in the 16- and 19-meter bands; CHTA, a newcomer in Montreal on 15.220, is heard until sign-off at 7 pm.; JTL3 in Tokyo on 15.225 puts in a good signal on the east coast at 6:15 to 8:15 pm. VLC4 in Melbourne puts a very good signal all over North America on 15.315

megacycles at 1:10 to 1:40 am. It is really worth sitting up to listen to once or twice. Melbourne is also good at 11 am. on 9.615 megacycles. Melbourne also uses a frequency of 11.840 on both of these transmissions, but is not very well received in the east, although it is heard well on the west coast. KRHO in Honolulu, Hawaii, comes in very well on 17.800 megacycles. They are on 7:30 pm to 3 am, but are heard very well here on the east coast until about midnight to 3 am., considering their beam is away from us. They use an Oriental directed beam on all of their transmissions. On the lower frequencies, Ponta del Gada, in the Azores, is being heard regularly on 11.090 during the afternoon, usually

2 to 3 pm. They put in a fair signal. Brazzaville is still being heard with a good signal on 9.440 megacycles and on 11.970 megacycles. They give the news in English at 6:15 pm. and other times during the evening. TAP in Ankara, Turkey, may be heard afternoons at 1 and 4 pm on 9.465 megacycles. CSW in Madrid, Spain, comes in with a very good signal on 9.370 megacycles from 7:30 to 9:30 pm. They sign on and off in English but use Spanish the rest of the time. Let's hear from some more of you. The more reports we receive, the better our log can be kept. The address is Elmer R. Fuller, c/o Radio-Craft, 25 West Broadway, New York City 7. All schedules are on Eastern War Time.

Freq.	Station	Location and Schedule	Freq.	Station	Location and Schedule	Freq.	Station	Location and Schedule
2.500	WWV	WASHINGTON, D. C.; U. S. Bureau of Standards; 7 pm to 9 am.	5.885	ZRK	CAPTOWN, SOUTH AFRICA; 11:45 pm to 2:30 am; 11 am to 5:10 pm.	6.110	GSL	LONDON, ENGLAND; North America beam; 5:15 pm to 12:45 am.
2.880	GRC	LONDON, ENGLAND; North American Beam; 8 pm to 12:45 am.	5.895	OAX4Z	LIMA, PERU; 7 pm to 12:30 am.	6.120	WDOW	NEW YORK CITY; European beam.
3.400	YV5RW	CARACAS, VENEZUELA; 7 to 10:30 pm.	5.945	PJCI	WILLEMSTEAD, CURACAO; Saturdays only. 12 to 12:45 am.	6.120	KRHO	HONOLULU, HAWAII; Oriental beam; 3:15 to 11:45 am.
3.460	YV4RP	VALENCIA, VENEZUELA; 9 to 10:30 pm.	5.955	HH2S	PORT-AU-PRINCE, HAITI; 7 to 10:30 pm.	6.125	GWA	LONDON, ENGLAND.
3.480	YV4RQ	PURTO CABALLO, VENEZUELA; off at 10 pm.	5.970	VONH	ST. JOHNS, NEWFOUNDLAND; 11 am to 1 pm; 4 to 9 pm.	6.130	CHNX	HALLIFAX, NOVA SCOTIA.
3.500	YV5RX	CARACAS, VENEZUELA; sked not known.	6.000	ZFY	GEORGETOWN, BRITISH GUIANA; daily 6:45 to 7:15 am; 10:45 am to 12:45 pm; 3:45 to 8:15 pm; Sundays, 6:45 to 9:45 am; 2:45 to 8:15 pm.	6.130	COCD	HAVANA, CUBA; 10 am to 11 pm; sometimes later.
3.500	COCX	HAVANA, CUBA; heard evenings.	6.000	XEBT	MEXICO CITY, MEXICO; 9:45 to 1 am.	6.130	JZH4	TOKYO, JAPAN; 8 to 9:30 am.
3.510	YV6RC	BARQUISMETO, VENEZUELA.	6.000	ZOY	ACCRA, GOLD COAST; heard occasionally at midnight.	6.140	XGOY	SUVA, FIJI ISLANDS; Sundays, 1:55 to 5:30 pm; Tuesday, 4 to 5 pm; Sunday to Thursday, 4:10 to 5 pm; 8 to 9:30 am.
4.020	ZQI	PONTA DEL GADA, AZORES.	6.005	CFCX	MONTREAL, CANADA; Sunday, 7:30 am to midnight; Monday to Saturday, 6:45 am to midnight.	6.145	HJDE	CHUNGKING, CHINA; 7:30 to 11:30 am.
4.700	HJFB	BRITISH WEST INDIES; 5 to 7:30 pm.	6.010	VE9AI	EDMONTON, CANADA; midnight to 2 am.	6.150	GRW	MEDELLIN, COLOMBIA; 5 to 11:30 pm.
4.765	HJAB	MANZALES, COLOMBIA; heard at 10:45 pm.	6.017	ZRH	JOHANNESBURG, SOUTH AFRICA; midnight to 3 am; except Saturdays.	6.150	CJRO	LONDON, ENGLAND; Near East, midnight to 1:30 am; 4 to 5 pm; South American beam, 6 to 10:15 pm.
4.785	HJAB	BARRANQUILLA, COLOMBIA; 6 to 11:55 pm.	6.018	GRB	JOHANNESBURG, SOUTH AFRICA; 11:55 pm.	6.160	HJCD	WINNIPEG, CANADA; heard at midnight.
4.830	YV2RN	SAN CHRISTOBAL, VENEZUELA.	6.018	CJCK	LONDON, ENGLAND.	6.160	CBRX	BOGOTA, COLOMBIA; heard at 11:50 pm.
4.830	YV2RN	CARACAS, VENEZUELA; heard at 10:30 pm.	6.018	HJXC	SYDNEY, NOVA SCOTIA.	6.165	GWK	VANCOUVER, CANADA.
4.855	HJCA	BOGOTA, COLOMBIA; evenings.	6.023	XEUW	BOGOTA, COLOMBIA; heard at 11:55 pm.	6.165	HER3	LONDON, ENGLAND.
4.880	HJFH	ARRENIA, COLOMBIA; heard at 10:00 pm.	6.035	GWS	VERA CRUZ, MEXICO; 8 am to 1:45 am.	6.165	HER3	LONDON, ENGLAND.
4.890	YV5RM	CARACAS, VENEZUELA; evenings, usually weak.	6.040	WRUW	LONDON, ENGLAND.	6.180	XGEA	BERN, SWITZERLAND; 9:30 to 11 pm except Saturdays.
4.895	YDP3	SOERABAYA, NETHERLANDS INDIES; heard at 8:45 pm.	6.050	GSA	BOSTON, MASSACHUSETTS; Central American beam, 9:30 to 2 am.	6.180	GRO	CHUNGKING, CHINA; feminine announcer at 10:30 and 11:30 am.
4.920	YV5RN	CARACAS, VENEZUELA; heard at 8:30 pm.	6.060	WCBN	LONDON, ENGLAND.	6.180	HJCT	LONDON, ENGLAND.
4.925	HJAP	CARTAGENA, COLOMBIA; 10 am to 2 pm; 8 to 11 pm.	6.065	LRS1	NEW YORK CITY; Mexican beam, 7:30 pm to 2 am.	6.190	JLT	BOGOTA, COLOMBIA.
4.945	HJCV	BOGOTA, COLOMBIA; 7:45 am to 12:15 pm; 5 to 7 pm; 8 pm to 12:15 am.	6.070	CFRX	BUENOS AIRES, ARGENTINA; 5 to 11 pm.	6.190	VUD7	TOKYO, JAPAN; 9 to 10:40 am; 11 am to 2:40 pm.
4.955	HJCO	BOGOTA, COLOMBIA; evenings.	6.070	GRR	TORONTO, CANADA; Sundays, 9 am to midnight; Monday to Friday, 7:30 am to 12:35 am; Saturdays, 7:30 am to 12:45 am.	6.195	GRN	DELHI, INDIA; 12:15 to 2:45 pm; 8:30 to 10 pm; 11:55 pm to 12:30 am; 9 to 10 am; 11 am to noon.
4.965	HJAE	CARTAGENA, COLOMBIA; heard at 8:30 pm.	6.070	GRR	LONDON, ENGLAND.	6.200	YV6RV	LONDON, ENGLAND.
4.990	YV3RN	BARQUISMETO, VENEZUELA; evenings.	6.070	GRR	PETROPAVLOVSK, U.S.S.R.; 4:45 to 7:30 am; 7:40 to 8:20 am.	6.220	TG2-	BOLIVAR, VENEZUELA; heard at 11:45 pm.
5.145	PMY	BANDOEING, NETHERLANDS INDIES; heard evenings occasionally.	6.080	WLWK	CINCINNATI, OHIO; South American Beam, 8:30 pm to 1:15 am.	6.220	TG2-	GUATEMALA CITY, GUATEMALA; 7 pm to midnight.
5.400		BANDOEING, NETHERLANDS INDIES; early mornings occasionally.	6.090	GWM	LONDON, ENGLAND.	6.230		MOSCOW, U.S.S.R.; heard early evenings.
5.750	PZX3	PARAMARIBO, SURINAM; 7 to 9:45 pm.	6.090	ZNS2	NASSAU, BAHAMAS; heard at 6 pm.	6.235	HRD2	LA CEIBA, HONDURAS; 8:30 to 11 pm.
5.875	HRN	TEGUCIGALPA, HONDURAS; 9 to 11 am; 7 pm to midnight.	6.100	CBFW	VERCHERES, CANADA.	6.240	HCBJ	QUITO, ECUADOR; evenings.
			6.100	VPD2	SUVA, FIJI ISLANDS; 1 to 3 am.	6.243	HIIN	CIUDAD TRUJILLO, DOMINICAN REPUBLIC; evenings.
			6.105	KGOJ	LOS ANGELES, CALIFORNIA; Australian beam, 5 to 9 am.	6.280	HIIZ	CIUDAD TRUJILLO, DOMINICAN REPUBLIC.



Suggested by: Vernon Berkhart, Jr., Barnesville, Ohio
"I stopped building ships in bottles after the Navy taught me radio."

6.235	HRD2	LA CEIBA, HONDURAS; 8:30 to 11 pm.
6.240	HCBJ	QUITO, ECUADOR; evenings.
6.243	HIIN	CIUDAD TRUJILLO, DOMINICAN REPUBLIC; evenings.
6.280	HIIZ	CIUDAD TRUJILLO, DOMINICAN REPUBLIC.
6.315	HIIZ	CIUDAD TRUJILLO, DOMINICAN REPUBLIC; 5 to 10:30 pm.
6.330	COCW	HAVANA, CUBA; 8 am to 11 pm.
6.345	HEI2	BERN, SWITZERLAND; 5:30 to 6:30 pm; 9:30 to 11 pm.
6.357	HRPI	SAN PEDRO SULA, HONDURAS; 7 to 8:30 am; 7:30 to 11:30 pm.
6.370	WLWS1	CINCINNATI, OHIO; South American beam, 6:45 to 8:30 am.
6.455	COH1	SANTA CLARA, CUBA; 9 am to 2 am.
6.465	TGWB	GUATEMALA CITY, GUATEMALA; 9 to 10 am; 7:30 pm to 2 am; Sundays, noon to 6:30 pm; 8 pm to 1 am.
6.480		MOSCOW, U.S.S.R.; heard at 7:25 pm.
6.490	CBR	VANCOUVER, CANADA; 9 to 9:30 pm.
6.715	ZLT7	WELLINGTON, NEW ZEALAND.
6.760	YNDS	MANAGUA, NICARAGUA; 9 to 11 am; 8 pm to 1 am.
6.910	YNQW	MANAGUA, NICARAGUA.
6.980		MOSCOW, U.S.S.R.; heard at 7:25 pm.
7.010	XPSA	KWEIYANG, CHINA; heard 10:30 pm to 12:15 am; also 4 to 9 am.
7.053	COCL	HAVANA, CUBA.
7.065	GRS	LONDON, ENGLAND; African beam, 9 pm to 4:30 am; 3:30 to 6:30 pm; Mediterranean beam, midnight to 4:30 am; 1 to 6:30 pm; Italy beam, 11:45 am to 6:30 pm.
7.100		HAVANA, CUBA; heard at 9:30 pm.

(Continued on page 795)

SURVEY OF PARTS NEEDED

A SURVEY of manufacturers' postwar requirements and capabilities is essential if the industry is to go smoothly into production of peacetime radio receivers and equipment. This is the opinion of Samuel J. Novick, president of the Electronic Corporation of America, as embodied in a letter to the Radio Manufacturers Association.

Manufacturers today are ordering what they can, where they can, with little thought as to the end result. As matters now stand, a concern which has 100,000 speakers on order may find itself compelled to accept delivery, yet have a totally inadequate supply of tubes for one-tenth that number of sets. Meanwhile another man may have five million tubes on order, though he cannot use half a million. (Number of tubes ordered, believes Mr. Novick, must now look like the national debt.)

The suggested survey would first find out, from parts manufacturers, (a) How many components are on order; (b) component production capacity; and (c) when and in what amounts components can be delivered. A parallel survey would be conducted among set manufacturers to find out the potential set manufacturing capacity, anticipated production figures for each manufacturer, and the amounts and kind of components ordered.

With these figures, unrealistic as they are bound to be, it should be possible to estimate—within reasonable limits—the potential production of both parts and sets. On the basis of these figures, each individual manufacturer should be able to plan intelligently his postwar activities. It might even be possible to develop a plan for organizing production and delivery so that production plans can be based on actual knowledge and schedules set up accordingly.

The situation, it was pointed out, would no doubt work itself out under the action of the natural laws of business, but only after a long time and at the cost of ruining a number of manufacturers.

ELECTRON CONTROL STICK



Air Technical Service Command Photo

This electronic control stick, developed by the Technical Air Service Command and manufactured by Minneapolis-Honeywell, permits control of the heaviest bomber with a one-pound pull instead of more than 100 pounds.



*Higher
and Higher*

Electronic Winding Co. has developed special high quality coils for Ultra High Frequency work. Development of our coils has kept pace constantly with the development of high frequency communications equipment and out of our intensive war experience will come a new and finer product ready to do a new and finer job on the rapidly expanding frontiers of radio communications.

Electronic Winding Co.

5031 BROADWAY
CHICAGO 40, ILL.

★ ★ MANUFACTURERS OF EXTRA
QUALITY COILS FOR PRECISION
COMMUNICATIONS EQUIPMENT

New Radio-Electronic Devices

HIGH-FREQUENCY TUBE

Federal Telephone and Radio Corp.
New York, N. Y.

THIS most powerful high frequency tube, with an output of 200 kilowatts, is manufactured especially for use in high power, high frequency broadcasting, FM broadcasting and industrial heating applications.

Incorporating a low inductance grid lead, with very complete shielding between filament and plate, the new tube has three electrodes, and an available emission of 120 amperes.

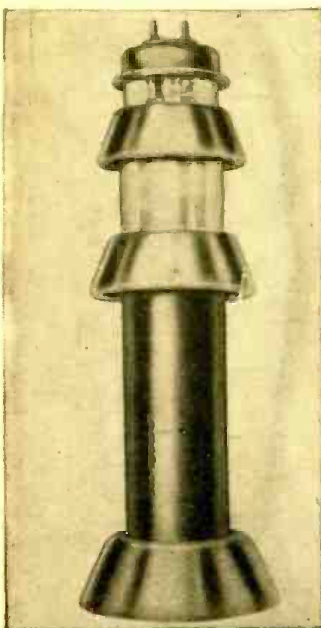

Specifications for the tube set the power output at 200 kilowatts per tube when operated as an oscillator or in Class C Telegraphy, with a plate voltage of 18 kilovolts and a plate dissipation of 150 kilowatts. In operation as a Class C Plate Modulated Amplifier the carrier power output is set at 100 kilowatts per tube with a plate voltage of 12.5 kilovolts, the peak instantaneous power output at full modulation being 400 KW per tube.

Cooling of the tube is accomplished by water, a steady flow of 40 gallons per minute being required for this purpose.—Radio-Craft

150-WATT SPEAKER

University Laboratories
New York, N. Y.

THE new University Model B-6 is a high powered directional loud-speaker for long range speech projection through high noise levels. Range is approximately one mile over open country and two miles over wat-

er. Primarily designed for speech reproduction, it has a frequency range of 300 to 5000 cycles per second and handles 150 watts of audio power.



This speaker is extremely rugged and incorporates blast-proof diaphragms for withstanding concussion from nearby large caliber guns.

Completely water-proof construction permits continuous outdoor exposure and the speaker may actually be submerged in salt water without damage. After such immersion, the unit functions normally immediately after drainage of the sound channels. It is also buoyant in water.

Six driver units power the speaker. These are connected in series with a high impedance reactor shunted across each coil. Failure of a coil due to an open connection results in automatic lowering of the shunt reactor impedance and continued functioning of the remaining driver units. The loud-speaker will thus operate even with only a single undamaged driver unit. The acoustic output will of course drop proportionally.

Physical dimensions: Diameter approx. 18 inches, length overall 24 inches. Weight 60 lbs.—Radio-Craft

DYNAMOTOR

Carter Motor Co.
Chicago, Illinois

THE heavy drain on storage batteries by the use of several electric motor-generators in mobile equipment has been reduced by the development of the Multi-Output Dynamotor.

The Multi-Output Dynamotor answers the requirement for different power supplies from the same unit, and hence the

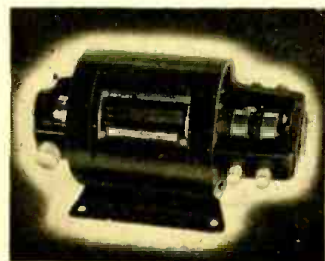

same space. It is possible, for instance, to use 6.3-volts A.C., as well as "B" power for the receiver and also have the high-voltage for the transmitter available at the flick of a switch—all of these from the same generator.

Where space is at a premium—wherever a receiver and transmitter must be used in a car or plane—or where AC and DC are wanted at the same time, the Multi-Output Dynamotor fills the bill in a single unit.—Radio-Craft

LOUD-SPEAKER

Jensen Radio Mfg. Co.
Chicago, Illinois

TYPE NF-300 Reproducer was originally developed for use as a loud-speaker and microphone (talk back) in ship intercommunicating systems so it



has all of the physical and audio features of reliability and performance required of sea going, battle-tested intercommunication equipment.

Unusual compactness is achieved by a uniquely designed reflex horn, the rim of which provides for panel mounting, while carrying the protective screen assembly. The Alnico 5 permanent magnet material is used, giving exceptional field strength in minimum space. The diaphragm is of moulded phenolic and the sound chamber is a combination of moulded bakelite and metal castings. The voice coil impedance is 12 ohms, nominal value. Maximum power handling capacity for speech is 10 watts.

While Type NF-300 Reproducer is a special purpose speaker, it nevertheless meets a wide demand for speech reinforcement, understandable through high ambient noise and where severe weather and the most trying operating conditions must be coped with. The design accentuates speech frequency, enabling the reproducer to override wind and background noise.—Radio-Craft

LIMITER AMPLIFIER

Altec Lansing Corporation
Hollywood, Calif.

THIS is a new version of a 70DB gain, 5-watt limiting amplifier which effectively elim-



inates thumping and monkey chatter in radio broadcast work and other fields of quality sound reproduction. In operation, the new amplifier permits a total input attenuation of 30DB in 1DB steps.

It provides ten to one compression beyond the limiting point; permits a five to six DB limiting action without being apparent to the ear; permits limiting of up to fifteen or twenty DB without distortion; provides a valuable safety factor in high power radio and public address installations and effectively reduces over modulation without distortion.

The new limiter amplifier has a frequency characteristic of a plus or minus one DB over a range of from twenty to twenty thousand cycles. The unit is designed for relay rack mounting.—Radio-Craft

TRANSMITTER

Bendix Radio Division
Baltimore, Md.

USING a single crystal, a compact, eight channel mobile service for the 100-156 megacycle band has been developed. The new transmitter is adapted to use in any type of mobile service and can be quickly converted from amplitude to frequency modulation.

A new three dial, eight channel, automatic shifter used in the unit has many possibilities in multi-channel applications. The number of dials could be varied on the basic design from one to ten, and as high as sixteen channels could ultimately be incorporated into design.

On any one of the eight channels, frequencies are accurately determined by dial calibration without the use of a crystal frequency indicating device.—Radio-Craft

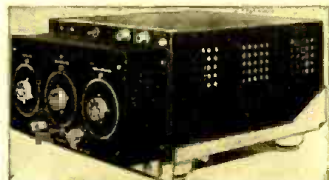

OBSERVATION DOES IT!

(Continued from page 771)

lug of the tube socket. A loud click will be heard when you have located the right one. If it proves to be an I.F. stage, everything apparently normal, put a resistor of as high a value as possible across the primary winding of the I.F. transformer. This will stop the oscillation. Usually 50,000 ohms will take care of it.

Distortion is the cause of many complaints so I will include some information which may be of some aid in locating the trouble, especially for the beginning serviceman.

Let us go back to locating the defective section, then the defective stage, and finally the defective part. After a little practice the serviceman will be able to distinguish by ear whether the trouble is in the R.F., audio, or speaker. However, touching the first audio tube grid may tell the story. A rattle will indicate speaker trouble. A distorted buzz proves the trouble is in the audio, a clear buzz indicates it is probably in the R.F. section.

If the distortion is traced to the audio amplifier, check all voltages carefully, especially the bias. Be sure it is correct before leaving it. 25—Check the voltage, grid to cathode. If it is resistance-coupled you won't get much indication of voltage, but must have some indication on the output stage. 26—The grid must have some negative voltage. If not, check the coupling condenser. If it is shorted or leaky the power tube may become very hot.

27—A shorted output transformer will cause poor tone. If it has been replaced with another, be sure the load matches the characteristics of the power tube.

28—If you are using the usual 1000-ohm-per-volt test meter, place your leads from grid to ground on all stages, as the grid may be floating. This may clear the tone. If so, replace the grid resistor. If the first audio tube is of the pentode type with a series screen resistor you may not read much voltage. However, turn your volt meter scales down. This may not increase the deflection, but it will lower the supply voltage to the screen. A high voltage here will cause distortion.

If the distortion trouble has shown up since you have been working on the set, you have probably caused it yourself. Check over the work you have done for defective parts, poor soldering or wrong connections.

R.F. distortion may be due to misalignment or to the wrong bias voltage. Check for both.

If distortion is only on strong signals, disconnect the antenna. If this clears up distortion you can be sure it is due to wrong bias voltage. On the older sets using 24's, etc., voltage under 25 volts on the screen or over 12 volts on the grid will cause the tube to be unstable. It will be necessary to install super-control tubes or a local-distance switch to lessen pickup.

Again check the tubes as to their right positions in sockets. A sharp cut-off type like the 6J7 will not replace a super-control tube of the 6K7 type, where the volume is controlled by the C-bias either manually or with automatic volume control, which includes almost all sets in use today.

Be thorough. Don't skip a stage until you have checked everything. Particularly, don't take it for granted that the tubes are in the right places, even though you may have replaced them in the sockets yourself. CHECK THEM AGAIN.



SLIDE RULE or SCREWDRIVER

... which will YOU be using 2 years from now!

Add CREI technical training to your present experience—then get that better radio job you want—make more money—enjoy security

Thousands of new men have joined the ranks of the radio industry during the war. But now, and after final peace, even more thousands will return from the armed forces. War production will settle down to supplying civilian needs. Where will you fit into this picture?

If you are wise, you will look ahead and prepare for the good-paying jobs in radio-electronics and industrial electronics. Every man in radio today has the opportunity to see the amazing developments that are taking place, as well as the unlimited opportunities available to men with modern technical training.

It is up to you to decide if you will be a "screwdriver" mechanic or a real technician in a responsible engineering position.

CREI can help you prepare by providing you with a proved program of home study training that will increase your technical ability and equip you to advance to the better-paying radio jobs that offer security and opportunity. The facts about CREI and what it can do for you are printed in a 36-page booklet. It is well worth your reading. Send for it today.



**WRITE FOR
FREE 36-PAGE
BOOKLET**

"Your Opportunity in
the New World of
Electronics"

If you have had professional or amateur radio experience and want to make more money, let us prove to you we have something you need to qualify for a better radio job. To help us intelligently answer your inquiry—PLEASE STATE BRIEFLY YOUR BACKGROUND OF EXPERIENCE, EDUCATION AND PRESENT POSITION.

CAPITOL RADIO ENGINEERING INSTITUTE

HOME STUDY COURSES IN PRACTICAL RADIO-ELECTRONICS
ENGINEERING FOR PROFESSIONAL SELF-IMPROVEMENT

Dept. RC-9, 3224 16th St., N.W., Washington 10, D.C.

Contractors to U. S. Navy—U. S. Coast Guard—Canadian Broadcasting Corp.
Producers of Well-trained Technical Radiomen for Industry.

MEMBER: NATIONAL COUNCIL OF TECHNICAL SCHOOLS

Radio-Electronic Circuits

ONE-TUBER

Figure 1

Here is a hook-up that has been found to give highly satisfactory results for a one-tuber. It is a regenerative circuit using a 1Q5-GT and operating on five flashlight batteries. This arrangement eliminates the hard-to-get radio batteries. Four of the cells are used for the 6-volt B supply and one cell for the A or filament supply.

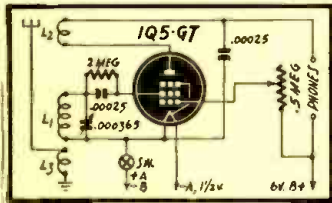

Figure 1

The coil is wound with No. 30 enamelled wire on a 1 1/2-inch form. Coils L1, L2, and L3 contain 90, 50, and 30 turns respectively. The large tickler coil is necessary for better regeneration with the low B supply. I have received San Francisco and New York City clearly from down here in south Texas with this set, using a good ground and a good antenna. This set can be built, batteries and all, into an average size cigar box for portability.

JIM GARY
Kennedy, Texas

TRF RECEIVER

Figure 2

Here is a hook-up of a small TRF receiver using the 1D8GT multi-element tube as detector, AVC, audio and power amplifier.

This circuit gives ample volume to drive a small speaker, has very sharp tuning and very low noise level as its chief points of merit.

CPL. M. J. THORNHILL,
U. S. Army.

PHONO AMPLIFIER

Figure 3

This phono amplifier utilizes some old 2.5 volt tubes which were lying around in the junk box. It provides ample volume for a small room. One side of the filaments is connected to the

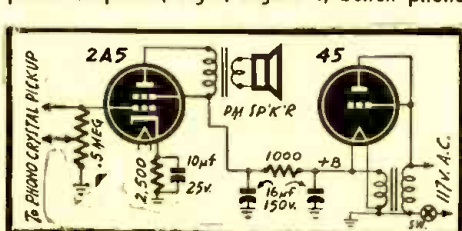
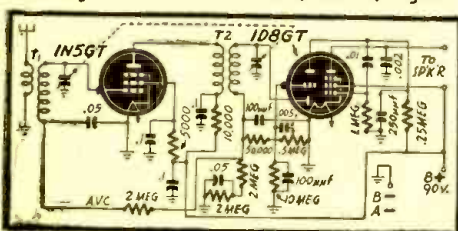

Left, Figure 2, two-tube radio; center, Figure 3, phono amplifier; right, Figure 4, bench phone.

Radio-Craft welcomes new and original radio or electronic circuits. Hook-ups which show no advance on or advantages over previously published circuits are not interesting to us. Send in your latest hook-ups—Radio-Craft will extend a one-year subscription for each one accepted. Pencil diagrams—with short descriptions of the circuit—will be acceptable, but must be clearly drawn on a good-sized sheet of paper.

B-plus, which prevents emission from the filament to the cathode because of the higher positive potential with respect to the cathode.

BILL BUEHRLE, JR.
Ferguson, Missouri

2-STAGE AMPLIFIER

Figure 4

This two-stage, resistance-coupled amplifier was used to good advantage in talking to students grouped around a U-shaped bench. Outside noises, combined with other instructors talking loudly to their students, induced me to build the circuit. It has sufficient gain to enable good reception and is very clear and distinct.

The 20,000-ohm resistor and 0.5-mfd. condenser in the B-plus line serves as additional filter and also to decouple the two stages. The inductor in the output tube's plate circuit was an old 1:3 audio transformer with a burned-out primary. Six pair of headsets were used in parallel, though more could have been used.

The results were so good that a number were constructed for the various benches. Tubes used were either 6C5's, 6J5's or a single 6SN7.

ROSS C. FERRY,
Champaign, Illinois

1R5 SUPER-REGEN

Figure 5

When my younger brother in the Pacific theater of war asked for a small radio which could be used in receiving broadcasts from the United States and Australia, I designed a super-regenerative that would be economical, light in weight and sensitive for operation at remote locations.

After attempting to use several miniature tube types with-

out much success, I finally tried a 1R5 in triode connection, and found that the best sensitivity was obtained that way.

The oscillator (Grid No. 1) is used as the control grid and all other elements are connected together to form the plate. This arrangement provides tube characteristics that result in fairly low plate resistance and good transconductance for direct headphone operation.

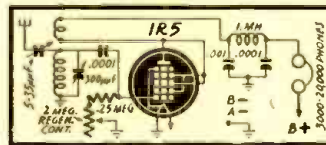

Figure 5

On the 19 meter band, using a 12 foot antenna, England, Panama, Argentina, Cuba, Chile, Brazil and Mexico were heard with good clarity.

The novelty of the circuit lies in the coefficient of coupling between the grid windings, and in the system of controlling regeneration. The circuit normally oscillates strongly, and is then damped by inserting a low value of resistance in the grid circuit. At the point of proper operation, a strong hiss will be heard in the headphones and the stations may then be tuned in. All circuit constants are shown in the diagram with the exception of coil inductance.

The builder may wind the coils to any frequency. The coils are wound as for normal regenerative operation with the addition of 40-50% more turns added to the tickler.

Generally this circuit works best at the higher frequencies and is not recommended for operation at frequencies below 7 megacycles.

BOB ESSEX,
Bronx, N. Y.

B-BATTERYLESS OSCILLATOR

Figure 6

This oscillator works with only one battery which is used to supply the filament voltage, the grid bias voltage and the plate voltage. With the proper combination of tube and audio

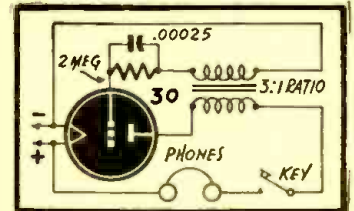

Figure 6

transformer it should function normally, but the proper combination must be found. It might be necessary to put a six-volt battery in series with the positive lead of the filament battery and the phones in order to get it to oscillate. A type 30 or a 1G4 tube is recommended for this oscillator.

HENRY BROWN
Washington, D. C.

HUM FILTER

Figure 7

In order to cut down hum in an A.C.-D.C. set, a resistor of about 150 ohms plus a filter condenser of say 20 mfd may be tried, inserted at the output B plus (cathode) of the rectifier tube such as the 25Z5 or 25Z6. The output tube does not need as much filtering as do the others, and the rest of the set will benefit by the new components and the lighter current through the choke. The diagram shows such an addition. A separate B plus lead is run to the power tube output transformer as shown.

H. A. NICKERSON
Dorchester, Mass.

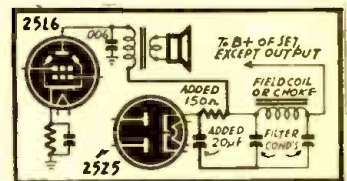

Figure 7

SUPERHET COIL DESIGN

By Sgt. Lionel R. Blattner

MANY experimenters like to design their own receivers and, if possible, design and construct their own coils. They are often stopped by the complexity of the design formulas concerned with finding the proper values of tuning inductance and capacity required for proper tracking of R.F. and oscillator circuits in a superheterodyne receiver. If they do happen to find long, involved and exact formulas for the necessary calculations they then discover that exact values so arrived at will not work without further trial and error methods.

The simplified method outlined in this article is based on the assumption that for all practical purposes approximate values of inductance and capacity will enable the experimenter to go ahead and be able to select and construct his components intelligently. Necessary adjustments will always have to be made, regardless of the accuracy of the calculations. It is sufficient to find an approximate range of values which will serve as a goal to aim at when the experimenter begins actual construction.

The first step consists of tabulating the characteristics of the projected receiver, its frequency range, its intermediate frequency, and so on. Let us follow a simple example through to completion as an illustration. For the sake of clarity round figures will be used wherever possible. Suppose you are designing a superheterodyne receiver to receive signals in the range of 1 to 3 megacycles and that you have available a two-gang variable tuning condenser with a capacity range of 20 to 180 micromicrofarads. The intermediate frequency is to be 500 kilocycles, or .5 megacycle. You must now know the value of inductance that will be necessary to permit your R.F. circuit to tune over the range of 1 to 3 megacycles with a 20 to 180 micromicrofarad variable condenser. This is found at either end of the band by the formula:

$$L = \frac{10^9}{4\pi^2 f^2 C} \text{ microhenries} =$$

$$\frac{39.44 \times 10^{12} \times 180 \times 10^{-12}}{10^9} = 139 \text{ (approx.)}$$

Since the formula is in basic units—cycles and farads—the 180-mmfd capacity is expressed as 180×10^{-12} . The other figures: 39.44 is $4\pi^2$ and 10^{12} is f^2 .

The R.F. coil must have an inductance of 139 microhenries.

Next you will want to construct your oscillator tuning coil. Start at the high end of the band first. The effective tuning capacity of the oscillator tank circuit at the high end of the band will be very nearly equal to the gang condenser setting at minimum capacity—in this case 20 micromicrofarads. We must therefore find the value of inductance which will tune with 20 micromicrofarads of capacity to produce a resonant frequency of 3.5 megacycles (since our intermediate frequency is .5 megacycle). Using the same formula again we now have:

$$L = \frac{10^9}{4\pi^2 f^2 C} \text{ microhenries} =$$

$$\frac{39.44 \times 3.5 \times 3.5 \times 10^{12} \times 20 \times 10^{-12}}{10^9} =$$

The oscillator coil must therefore have an inductance of 100 microhenries.

Now the inductance of the oscillator tank coil remains fixed under all conditions of tuning of the receiver. The oscillator circuit must be so designed that at the low end of the band it will produce a frequen-

PORTABLE POWER PROBLEMS

THIS MONTH—BROWN-DUVEL MOISTURE METER

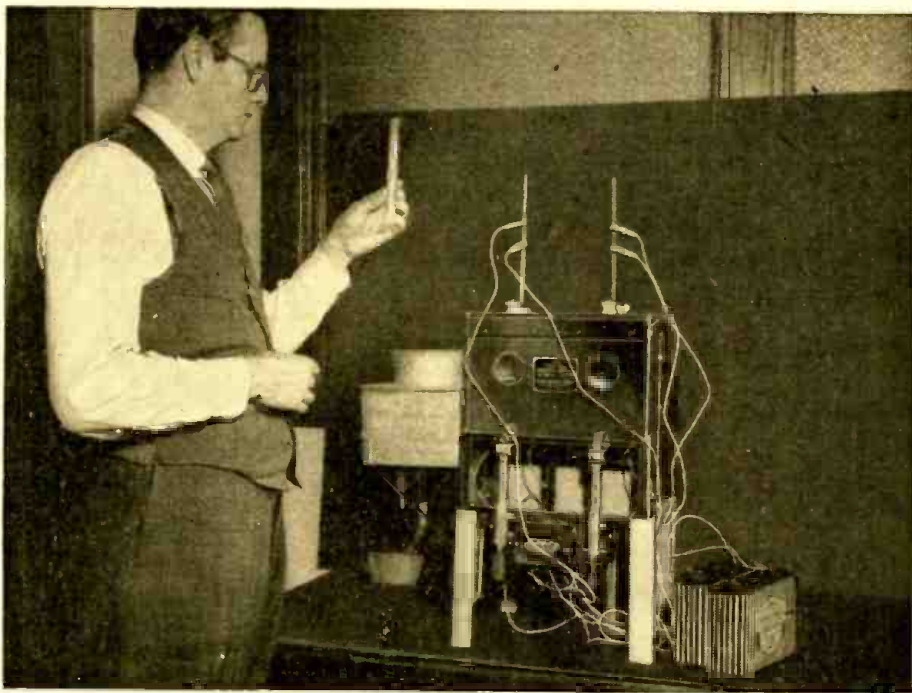

BURGESS INDUSTRIAL BATTERIES power the Brown-Duvel Moisture Tester, made by Seedburo Equipment Co., for the determination of moisture content in grain. And in thousands of similar industrial applications Burgess Batteries are providing the power for electronic test equipment. Purchasing agents and maintenance engineers know they can get a Burgess Battery for every need from their local Burgess distributor. For information on the complete line for all test and control instruments, write for the name and address of your nearest Burgess distributor.

ELECTRONIC ENGINEERS VOTED Burgess Industrial Batteries first choice in a recent nation-wide survey of dry battery preferences! If you need a special battery for a new instrument or a new application let Burgess engineers solve your problem by developing the correct battery type for you. *Burgess Battery Company, Freeport, Illinois.*



THE JOB AHEAD—JAPAN!

BURGESS BATTERIES

VOTED FIRST BY ENGINEERS IN NATION-WIDE INDUSTRIAL BATTERY SURVEY

cy of 1.5 megacycles with the same components. Starting with a coil of 100 microhenries inductance, we now have to find that value of capacity which will make the combination resonant at 1.5 megacycles. This is given by the formula:

$$C = \frac{10^{12}}{4\pi^2 f^2 L} \text{ micromicrofarads} =$$

$$\frac{39.44 \times 1.5 \times 1.5 \times 10^{12} \times 100 \times 10^{-6}}{10^{12}} = 111 \text{ (approx.)}$$

We must have a tank circuit capacity of 111 micromicrofarads. But at the low end of the band the capacity of our tuning condenser is 180 micromicrofarads. We must therefore connect a padding condenser in series with our oscillator tuning condenser of such a value that the series combination will have

a capacity of 111 micromicrofarads. The correct value of padding capacity to do the job is found from the following:

$$\frac{1}{180} + \frac{1}{X} = \frac{1}{111}$$

$$X = \frac{180 \times 111}{180 - 111} = 290 \text{ mmfd. (approx.)}$$

The padder will therefore have a capacity of 290 micromicrofarads. At this point our calculations have been completed and it is possible to proceed with our receiver.

Knowing the required inductance, it is possible to calculate the coil sizes to fit wire and forms at hand by the use of other standard formulas, or better, use one of the sets of charts by means of which number of turns may be found for almost any common size of wire and diameter of winding tube.

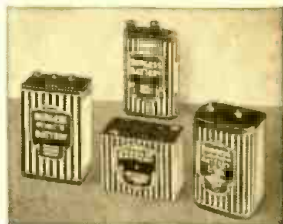
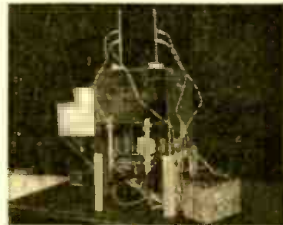

TRY THIS ONE!

POWER UNIT

I devised this power unit to supply 22½ volts for my combination oscillator-ohmmeter to replace batteries. The tester is a model 1180 Triplett Perpetual Tester, but this unit may be adapted to any similar outfit.

Since it is to be housed in the battery compartment, I made the unit very compact. The condenser checker is an additional convenience taking advantage of the 120 volts D.C.

Transformer "T" is a small output transformer with voice coil rewound for 5 volt secondary. With Sw2 open about 120 volts is available for testing condensers by means of the two neon lamps. The smaller lamp tests paper, the larger tests electrolytic condensers.

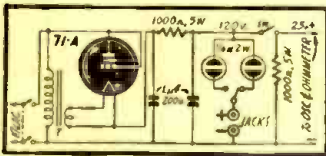

When Sw2 is closed, R2 shunts the output which drops to about 25 volts. The high bleeder current (.025 amp.) stabilizes the output, since the meter current (.0005 amp.) is a small percentage of that through R2. Ohmmeter readings will therefore be correct. Otherwise the voltage available would vary with each resistance being measured.

Sw1 isolates the power line from the unit when it is not in use. This is necessary because the minus terminal is connected to one side of the line. When the combination meter is used as voltmeter or milliammeter, opening Sw1 prevents a short.

C. W. BATTELS,
Akron, Ohio.

POWER SUPPLY

Having burned out a 50Z6 and having an OZ4 on the shelf, I devised this circuit using an ordinary output transformer of 8 watts rating. This put the small radio back in playing condition.

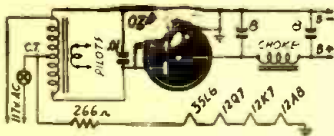

The advantage of such a circuit is that it doubles the voltage and in addition has a tap for the pilot lamp.

Care must be taken that a resistor of the proper value be placed in the filament circuit of the tube that has been removed.

WILBUR RATZLAFF,
Goessel, Kans.

Radio-Craft wants original kinks from its readers, and will award a seven-month subscription for each one published. To be accepted, ideas must be new and useful. Send your pet short-cut or new idea in today!

INTERCOM

This intercom is just the thing that has long been needed for the service man, the researcher, or the kids.

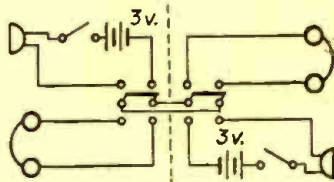

It requires no tubes and can be put together with a couple of old carbon microphones and two low-impedance telephone receivers or small PM speakers. The entire unit is mounted in a cigar-box. The double-pole double-throw switches should if possible be standard "talk-listen" switches which spring back into the "listen" position when released.

Two No. 6 dry cells supply the power. A PM speaker can be used in place of the headphones and the entire unit may be mounted in an ordinary cigar box. The diagram illus-

PLASTIC HANDLE

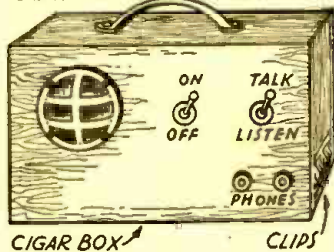

trates the hook-up and method of mounting.

EDWARD HOWELL,
Dillon, S. C.

PILOT LIGHT PULLER

This is one of the most useful tools in my kit for replacing pilot and indicator lamps. It can be made with an old cartridge fuse as the body and suitable pieces of rubber tubing cemented on each end as lamp grips. Select soft rubber tubing such as a piece of hose or the jacket on rubber cords of the J and



SJ types. With this gadget, the replacing of pilot lights in tight places is simplified.

CHARLES A. LANPHEAR
Anchorage, Alaska

BARE WIRE RESISTORS

It is frequently necessary to wind a wire-wound resistor of low ohmage with bare resistance wire. There is always the problem of what kind of form to wind the wire on and also how to wind it so as to prevent the turns from shorting. A quick solution to this problem which is satisfactory in a number of cases, is to cut off a strip of adhesive or surgical tape (preferably the waterproof type) about ¼ to ⅜ inch in width and of a length equal to the length of the wire required for the shunt. The resistance wire is then laid on the tape and the tape rolled up into a small roll. Put a right-angle bend on the starting end of the wire so that it will protrude from the center of the roll in order that a connection may be made to it. The wire will then be insulated by a layer of surgical tape between turns and a small compact resistor will result. Two feet of tape will form a roll which is around ⅝ of an inch in diameter.

R. S. HAVENHILL
Josephtown, Pa.

COMMON GROUND

When a number of leads are to be grounded, a neater job is made by using a common post consisting of soldering lugs mounted in staggered positions on a screw which is grounded to the chassis. The wires are then easily removable. If an insulated post is desired, the screw may be mounted in a rubber grommet or in a piece of fibre.

N. Z. RADIOGRAM,
Wellington, N. Z.

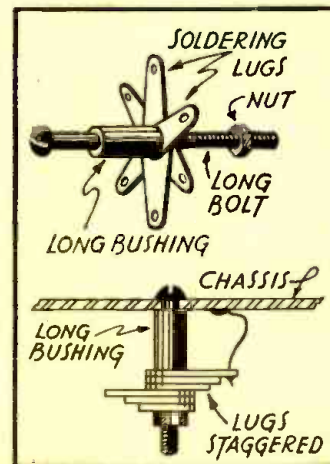

WIRE STRIPPER

Most servicemen do not care to spend money for a wire stripper. I have a very good idea which works nicely. Simply take a pocket knife and file or grind a notch in it, at about one inch from the pointed end and about



⅛ of an inch deep, tapering to form a phantom wedge.

HERMAN N. GOLDBREATH
Columbia City, Indiana

3.5-MFD. "RESISTOR"

I have an excellent way of substituting tubes. Most common of the methods used is the voltage-dropping resistor or line-cord resistance. My method employs a condenser which has as its main advantage, the fact that it does not give off heat as a resistor would.

The size of the condenser required for any particular case is determined by the formula;

$$X_C = \frac{1}{2\pi f C}$$

where X_C is the reactance (resistance required) 2π is 6.28 f is the frequency of the power supply (usually 60 cycles.)

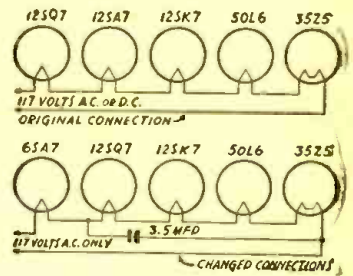

C is the capacity to be used. This formula can also be proposed to read;

$$C = \frac{1}{2\pi f X_C}$$

The circuit shown in the diagram illustrates the use of a 3.5-mfd. condenser instead of a voltage-dropping resistance of 20 ohms. Since there is a 104-volt drop to be taken up and since the tube draws .3 amp., with half of that supplied by the series tube line-up, we apply Ohm's Law to determine the resistance (reactance) required.

$$R = \frac{E}{I} = \frac{104}{.15} = 690$$

By applying that to the formula $C = \frac{1}{2\pi f X_C}$ we get

$$C = \frac{1}{6.28 \times 60 \times 690} \text{ or } 3.4 \text{ mfd.}$$

Therefore, we find that a 3.5-mfd. condenser will satisfactorily act as a resistance of 690 ohms, when used at 60 cycles A.C.

ALLAN BRADSHAW,
Milford, Conn.

Intercommunicator

By E. J. THOMPSON

DESIGNED to save steps in answering the doorbell due to frequent callers throughout the day, this intercommunication system may be put to many uses, including that of a phonograph amplifier.

It was designed with three considerations in mind; first, the expense involved is very low, a great many parts having been salvaged from discarded apparatus which many experimenters have laying around the workbench. Second, the components were so selected as to permit substitutions where one part is not available. For example, in place of the 35Z5 tube, a 35Z4, a 50Y6, or other rectifier tube may be used by changing the value of the dropping resistor, R6. Third, the circuit is as simple as it was possible to make it and still obtain suitable performance.

The circuit incorporates a resistance coupled stage of amplification, using permanent magnet speakers, capable of providing two-way communication with all the volume needed.

As previously mentioned, many parts may be salvaged from the experimenter's workbench. The chassis, tubes, tube sockets, and electrolytic condensers were so obtained, as was the master station's cabinet, made over from an old table model radio cabinet by filling up the undesired holes with panels and plastic wood. The microphone transformer T1, is nothing more than a discarded output transformer in reverse and works very well.

The system is so designed that, normally, the master station speaker is the receiver and the remote station speaker is the microphone. When the switch SW2 is depressed the reverse is true, the master station speaker then becoming the microphone and the remote station speaker becoming the receiver. This is accomplished by the switching arrangement which incorporates a four-circuit, two-position spring switch.

While it is of course possible to have the system turned on continuously, from the economy standpoint this is inadvisable, not only because of the cost involved for continuous operation, but also because it tends to shorten the life of the tubes. It has been found that it takes about 15 seconds for the unit to warm up for operation which is sufficient time to insure the caller is still at the door.

Additional speakers may of course be added, depending upon the needs of the reader. Their operation is easily controlled by means of a rotary switch.

To connect a phonograph pickup of the crystal high-impedance type, the leads should be connected at the points indicated in the diagram. The switch SW3 is opened to take the secondary of T1, out of the circuit, and the potentiometer used to limit the phono input. In this manner, the system may be used as an intercommunication sys-

SILVER

"VOMAX"

*The Answer to Post-War
Radio Design & Servicing*

When "VOMAX" — the post-war vacuum-tube volt-ohm-db-milliammeter and a.f.-f. signal-tracer — was announced June 1st, we rather expected "fire-works". We got them... two-to-one in firm orders. Created by a world-famous receiver engineer to satisfy his own design and production needs, "VOMAX" makes possible the complete measurements in radio servicing heretofore possible only in the heavily financed manufacturers laboratory.

"VOMAX" spells time saved in the design laboratory... greatly increased efficiency and ease in servicing... greater service profits. This is proved by the avalanche of priority orders received... steadily flowing in. Beginning where other test instruments leave off, "VOMAX" was immediately recognized for what it is... the key to modern, post-war radio design and service profits.

If you haven't already placed your order with your electronic distributor for the new revolutionary "VOMAX", may we suggest that you do so immediately? Shipments are in strict rotation... AA-5 serviceman-originated, or higher, priority will put you in line for radio's biggest dollar-value in service instruments.

1. Brand new post-war design... positively not a "warmed-over" pre-war model.

2. More than an "electronic" voltmeter, VOMAX is a true vacuum tube voltmeter in every voltage/resistance/db function.

3. Complete signal tracing from 20 cycles through over 100 megacycles by withdrawable r.f. diode probe.

4. 3 through 1800 volts, d.c. full scale in 6 ranges at 50, and in 6 added ranges to 3000 volts at 125, megohms input resistance.

5. 3 through 1900 volts a.c. full scale in 6 ranges at honest effective circuit loading of 0.6 megohms and 8 m.mfd.

6. 0.2 through 9000 megohms in six easily read ranges.

7. -10 through +50 db. (0 db = 1 mw in 600 ohms) in 3 ranges.

8. 1.9 ma through 12 amperes full scale in 6 d.c. ranges.

9. Absolutely stable — one zero adjustment sets all ranges. No probe shunting to set a meaningless zero which shifts as soon as probes are separated. Grid current errors completely eliminated.

10. Honest, factual accuracy ± 3% on d.c., ± 5% on a.c., 20w through 100 megacycles; ± 2% of full scale, ± 1% of indicated resistance value.

11. Only five color-differentiated scales on 4 3/4" D'Arsonval meter for 51 ranges (including d.c. volts polarity reversal) eliminate confusion.

12. Meter 100% protected against overload burnout on volts/ohms/db.

13. Substantial leather carrying handle. Size only 12 3/4" x 7 3/4" x 5 3/4".

New inventions you can obtain ONLY in "VOMAX" are what make heretofore unattainable results possible today.

NET PRICE
\$59.85

OVER 34 YEARS OF RADIO ENGINEERING ACHIEVEMENT

McMurdo Silver Company

1240 MAIN STREET, HARTFORD 3, CONNECTICUT

McMurdo Silver Company
1240 Main Street,
Hartford 3, Connecticut

Please RUSH free copy of your catalog

NAME _____

ADDRESS _____

CITY _____ STATE _____

tem or a phonograph amplifier by appropriate adjustment of the controls.

If a low impedance crystal pickup or a magnetic pickup is to be used, a suitable input transformer should be substituted for the input transformer T1. Some output

transformers may match a very low-impedance magnetic pickup, and an audio transformer will give fair results with others.

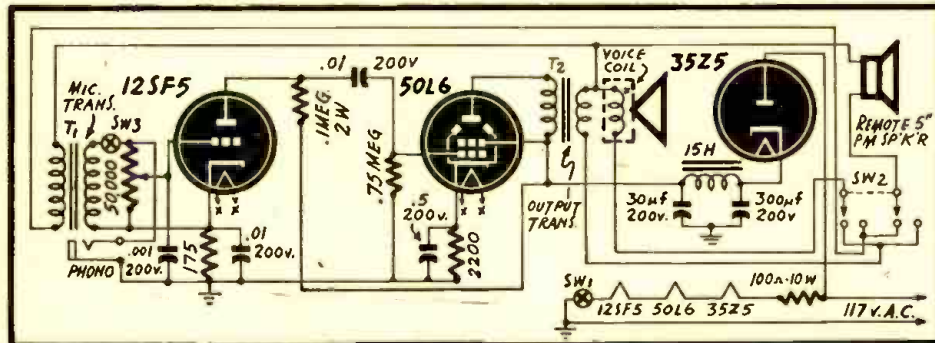

RADIO BETWEEN TWO WARS

Growth of electronics in the Fleet was strikingly shown up in a report comparing the staff engaged in radio and electronics at the present time with the number engaged in the same work at the end of World War I. At the time of the first armistice, the staff of the "Radio Division" numbered 75 officers and 25 civilians. In April, 1945, the Electronics Division was composed of 459 officers, 487 civilians and 214 WAVES, a total of 1160, eleven times the personnel just before our entry into the war and more than sixteen times as many as were in the corresponding group at the last armistice.

THE QUESTION BOX

CONVERSION

? I am interested in changing a battery set that operates from a single 6-volt storage battery, to an A.C.-D.C. 110-volt-60-cycle set. The radio is a Zenith Model 4-B-231. If such a scheme is possible, I would like to have it changed so that a minimum of expense is involved and with parts available from the average junk box.

I have a transformer, from a Crosley Model 124 and an 80 rectifier tube that could be used.

Would you please print a complete diagram of the changes necessary and how the power supply is to be made and coupled?—F.P., Cowlesville, N. Y.

A. The circuits illustrated appear to suit your requirements (see Figs. 1 and 2).

Your present speaker has a six volt, low resistance field coil and cannot be used as is on 110 volt power supplies. It is suggested that you try to obtain a permanent magnet type speaker but, if you wish, you may be able to install a higher resistance field coil. The resistance should be about 2,500 ohms.

When considering the A.C.-D.C. power supply, insulation of all metal parts connected with the chassis must be kept in mind to prevent shock. This hazard is not present if a good transformer is used. You may use the Crosley Model 124 transformer which you have but it has a 2.6 volt filament winding which would have to be rewound to 6.3 volts. This may not be difficult as, usually, the 2.5 volt winding is on the outside, and with care this can be rewound, counting the turns exactly. Multiply the present number of turns by 2.5 and the answer gives the correct turns for 6.3 volts.

Use magnet wire of about No. 20 B&S enamel or SCC. Of course to do the winding properly, the transformer will have to be disassembled and reassembled when finished. Articles on rewinding transformers appeared in September and October 1942 issues of *Radio-Craft*.

If for some reason you do not care to change the winding or are unable to do so, you may be able to purchase a small 6.3-volt filament transformer to operate the four filaments of the tubes. The filament transformer can be controlled by the same switch as for the main transformer.

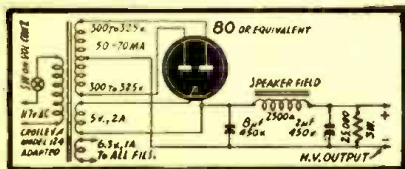

Figure 1

The Question Box is forced to discontinue answering questions until further notice. We have had great difficulty in securing skilled labor for this work, and in many cases recently have been forced to refund remittances. We will continue to print questions of general interest till those already answered and on hand have been exhausted or till we are again able to handle questions for readers.

FLUORESCENT

? Will you kindly print a diagram of a filter for a 15-watt fluorescent lamp to prevent static on the radio.—J.M.D., Trenton, N. J.

A. Three fluorescent filter types are shown in the diagram. Interference from fluorescent lamps occurs in three ways as follows:

1. Radiation direct from the lamp bulb to the antenna system.

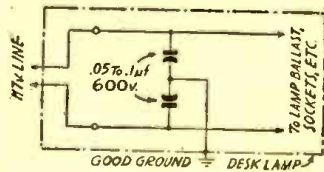

2. Radiation from fluorescent lamp power line to the radio antenna system.

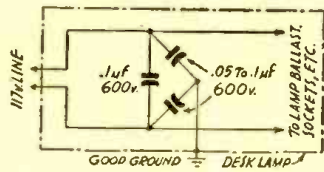

3. Feedback from the lamp unit through the power lines to the radio.

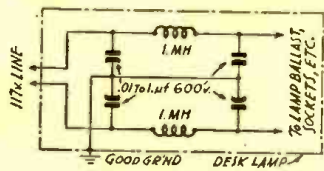

Direct radiation usually does not extend over ten feet and it can be eliminated if the radio and the lamp are separated a sufficient distance, or if a grounded metal screen is placed over the lamp, or if the metal parts of the lamp are properly grounded.

Power line radiation and feedback can best be eliminated by means of filters in the power line, preferably close to the

lamp. In your case perhaps there is room for a filter in the base of your lamp.

Occasionally, interference may be due to a defective lamp starter so it would be well to try a different one if you are not sure of the present one.

Of the diagrams shown, Fig. 1 is the simplest but will not handle severe interference. Fig. 3 is for the severe types and Fig. 2 is for the intermediate degrees of interference. The diagrams are self-explanatory, but before installing a filter it is advisable to make certain your interference is not due to direct radiation or starter trouble mentioned above.

Undoubtedly, you will be able to eliminate your trouble by following one or more of the methods outlined.

MIKE PRE-AMP

? Can you print a schematic diagram with instructions for constructing a one- or two-tube mike pre-amplifier which will bring the level of the mike up to approximately that of a phonograph pickup.

I'd prefer to use a 6C6 if possible. My set is a Crosley 61.—G.L.A., South Bend, Ind.

A. The circuit shown here (Figure 3) includes a mike pre-amplifier diagram and a diagram of your set. The connections between the two are as indicated.

The 370-ohm resistor in the filament circuit should be located in such a position that the heat of it will not damage other parts. Lamp bulbs (120 volt types) could be used in place of the resistor if their total wattage is about 35 watts, but not over that.

It will be necessary to observe usual precautions in placement, wiring, and shielding of parts to prevent oscillation.

Most likely the 6C6 will give you all the amplification needed but a 6SJ7 can be used to get slightly more gain, with no change in circuit.

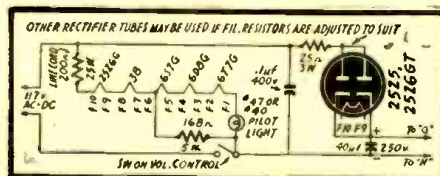

Figure 2

SIGNAL TRACER

? I need some help on a signal tracer which I have built as described in the June, 1942, "Radio-Craft."

I have been unable to get R.F. through the set although I get a good audio signal. When the test prod is placed on the R.F. signal of the set under test, the signal is immediately killed and will not come through the speaker of the signal tracer.

Can you suggest any reason why this should act that way?

I have also been unable to hook up an antenna coil and tuning condenser to tune in a local station to test tracer.—G.B., Boonville, Mo.

A. Perhaps your signal tracing probe and cable has too much capacity to the shield on the cable. (We assume the probe is of the signal-tracing type, with a very small condenser in the tip.) It is advisable that the cable be as short as is convenient to use and of very low capacity type. Other troubles may be in parts you have used on the R.F. end of the tracer, such as defective condensers, resistors, tube, or the tube socket.

Even a shorted resistor or condenser in the cathode circuit of the 6U7G will have a great killing effect on your R.F. signal and a nearly shorted or low resistance in the grid circuit has an even greater killing effect.

If all your parts are good and of nearly the correct value, and all correctly connected, an ordinary broadcast band antenna coil and tuning condenser having one side grounded and the other side connected directly to the grid of the 6U7G should give you reception from a local station.

CAR RADIOS

? I have many car radio repairs come into my shop. By the time I get anywhere with them, the battery goes dead. Can you print a circuit enabling me to run them from a 110-volt line if possible?—L.J.P., Revere, Mass.

A. The best method is to get an old-style battery charger and keep it across the battery while you are checking over the car radios. With the charger, even an old battery which will not hold a charge very long may be used.

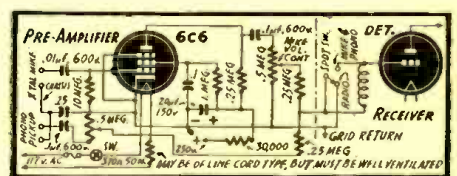

Figure 3

6A8 SUBSTITUTION

This is a simple substitution for the rare 6A8 or 12A8 tubes. The oscillator circuit with the —K7 type tubes is clearly shown in the diagram below.

The suppressor and plate of the 6K7 (or 12K7) are used as the oscillator section, the R.F. input coming in through the control grid. The screen grid shields the two grids. If tickler polarity is right, this circuit is a sure-fire oscillator.

This is the easiest and best substitution which I have found to work for this type of converter.

CHARLES C. HALL,
Wilmington, N. C.

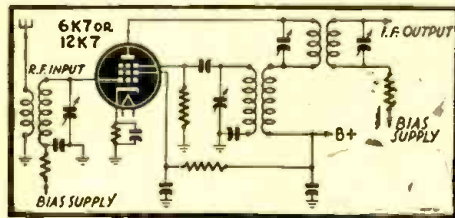

WHO SAID "RADIO" FIRST?

"A New York publication, *Radio-Craft*, says there has been a good deal of controversy over first use of the word 'radio' in the current sense, and gives the credit to Mr. Donald McNicol, a former Canadian. Mr. McNicol, it says, used the word in a series of articles he wrote in 1907 and 1908 for the Chicago publication, *Western Electrician*, under the general caption, 'Wireless or Radio Telegraphy.'

"Mr. McNicol, who is spending his vacation at Otty Lake, near Perth, writes *The Journal* to say *Radio-Craft* gives him too much credit. The word 'radio,' he says—instead of 'wireless,' which the British continue to use—'was pushed forward by the Germans at a 1903 conference in Berlin and was adopted in a 1906 protocol signed in Berlin by Germany and some other powers.' Mr. McNicol was, however, the first of this continent to employ the word 'radio,' in connection with space-telegraphy, through his articles in *Western Electrician*, but not for another decade did 'radio' replace 'wireless' generally in the United States and Canada."—*Ottawa (Canada) Evening Journal*



Suggested by: J. F. Dunnett, Vancouver, B. C.
"Driver to ground crew! Driver to ground crew! Coming in! Coming in!"

RIDER VOLUME XIV COVERS 1941-42 RECEIVERS

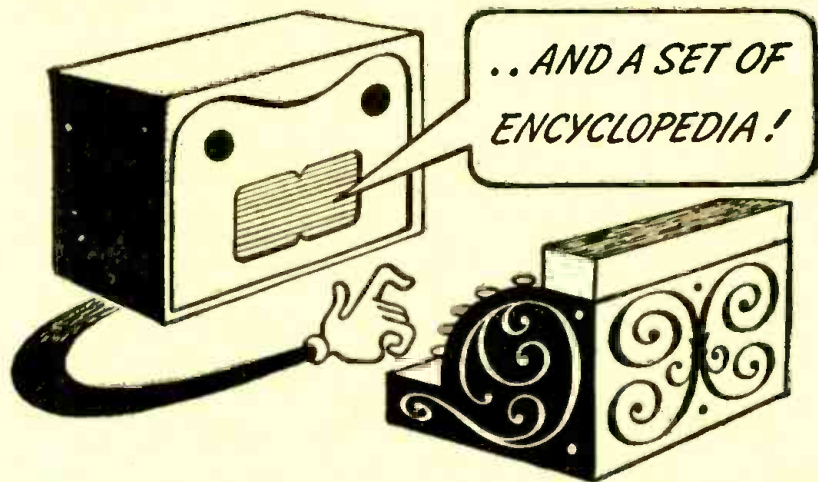

Even back in '41, when I was brand new, "Information Please" was giving sets of *Encyclopedia Britannica* to people who submitted questions that stumped the program's "experts."

If the "Information Please" people ever want to get hundreds of servicemen to stay up nights thinking of questions they can offer a "set of Rider Manuals," recognized as the most valuable piece of equipment in any shop.

That's why there's such a tremendous demand for Val. XIV right now. It contains the vital servicing data needed to quickly diagnose and cure the ills of radios of my age; the last generation born before the stoppage of civilian set manufacture.

We have been worked hard because of the war. For the same reason paper is scarce and WPB limitations on paper may cause your jobber to be out of a Rider Manual. Thanks for being patient.

- RIDER MANUALS (14 VOLUMES)**
- Volumes XIV to VII . . . 12.50 each volume
 - Volume VI 9.50
 - Abridged Manuals I to V (1 vol.) 15.00
 - Automatic Record Changers and Recorders 7.50
- OTHER RIDER BOOKS YOU NEED**
- The Cathode Ray Tube at Work
Accepted authority on subject 4.00
 - Frequency Modulation
Gives principles of FM radio 2.00
 - Servicing by Signal Tracing
Basic Method of radio servicing 4.00
 - Servicing Superheterodynes 2.00

- The Meter at Work
An elementary text on meters 2.00
- The Oscillator at Work
How to use, test and repair 2.50
- Vacuum Tube Voltmeters
Both theory and practice 2.50
- Automatic Frequency Control Systems
—also automatic tuning systems 1.75
- A-C Calculation Charts
Two to five times as fast as slide rule . . . 7.50
- Hour-A-Day-with-Rider Series—
On "Alternating Currents in Radio Receivers"—
On "Resonance & Alignment"—
On "Automatic Volume Control"—
On "D-C Voltage Distribution" 1.25 each

JOHN F. RIDER PUBLISHER, INC. 404 FOURTH AVE., N.Y. 16, N.Y.
Export Division: Rocke-International Corp. 13 E. 40th Street New York City Cable: ARLAB

RIDER MANUALS *are complete* IN 14 VOLUMES

RADIO-CRAFT SOUGHT BY NAZI SPIES

WITH the closing of a little New York bookshop known as Westermann's by FBI agents recently, it was revealed that *Radio-Craft* was one of the objects of spies seeking information on the latest in American radio and electronic devices, copies being ardently collected by them and sent to Germany. The shop was actually owned by a concern controlled by Alfred Hugenburg, Hitler's first Minister of Economics. Although it had been losing 25,000 dollars per year for the past few years, "stockholders" in Germany sent the manager more than 30,000 dollars in bonuses for good business practices which allegedly saved the firm money.

The true story of the bookshop was bare by the U. S. Treasury Department, which reports that since 1926, the bookshop

has acted as a collecting and forwarding station, from which large quantities of information on U.S. military developments had been sent to Berlin. Anything having to do with mechanical equipment of the United States armed services or to military strength and activities was of interest to Westermann's, and the little shop mailed out great stacks of such magazines as *Aero Digest*, *Coast Artillery Journal*, *Aviation Magazine* and *Radio-Craft* to interested "correspondents" in Berlin.

The bookshop's true role came to light, the Treasury stated, in 1941, after the mailing of books and other literature from the United States was banned. Mr. Eisele, who managed the bookshop, protested and asked exemption. Secret Service and FBI agents were assigned to find out why.

ALLEN Key Kits

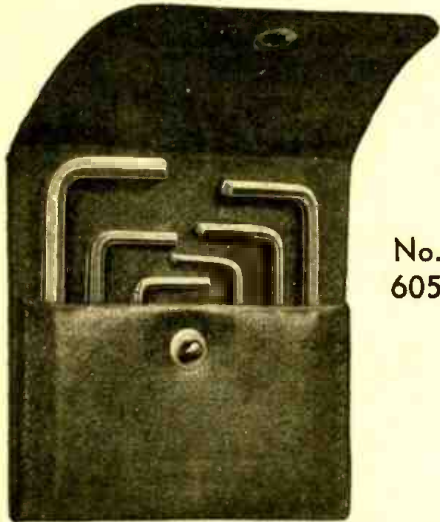

No.
605

VEST-PAC-KIT



No. 605 — Packet only 3" x 2 1/4" over-all contains 6 Hex Keys to fit hollow set screws in sizes No. 4, 5, 6, 8 and 10; also 1/4" and 5/16". Same keys fit socket head cap screws in sizes No. 4, 5, 6, 8 and 10. Most compact and serviceable little set you could ask for. List price, only 50¢.

Ask for complete listings of Allen Hollow Screw Assortments and Key Kits. Address inquiries and orders to Dep't. E,

THE ALLEN MFG. CO.,
HARTFORD 1, CONN., U. S. A.

Progress In Invention

Conducted by I. QUEEN

WIND MEASUREMENTS

Leon Hillman, New York City
Patent No. 2,375,227

WIND has both magnitude and direction so that two measurements must be made for meteorological purposes. For accurate measurements, devices must usually be located in exposed and elevated positions. It is therefore desirable to transmit the information to other points.

The two wind indications are conveniently transmitted to and observed on an oscilloscope. A rotating anemometer is coupled to a small A.C. generator G whose output is rectified by a copper oxide rectifier R giving pulses as shown. The wind velocity determines the amplitude of the pulses. An exposed wind vane is fixed to a rotor loop, through which these pulses pass, within two stator loops of a goniometer. The position of the rotor determines the ratio of voltage picked up by one stator to that of the other. The goniometer output is applied to the oscilloscope, which may be located at some distance from the goniometer and associated apparatus.

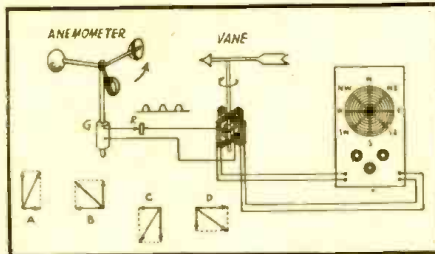

Operation is as follows. Since the pulses are D.C. the oscilloscope screen will show a straight line on one side of the center point. Its amplitude depends upon the A.C. generator voltage and therefore upon the wind velocity. The straight line will have a direction depending upon the position of the rotor within the two stators of the goniometer. This is clearly shown in the smaller figure, the resultant in each case being a vector sum of the two component voltages picked up by each stator.

Other types of indicating devices might be used, but the oscilloscope is most suitable.

TELEVISION PROJECTION

Thomas T. Goldsmith, Jr., Cedar Grove, N. J.
Patent No. 2,373,114

THIS discloses a new method for large-screen projection of received television images. Direct projection requires expensive and relatively short-life equipment. Here the incoming signals are passed through an additional video stage, producing a negative image on a high-brilliance, blue screen oscilloscope using about 10,000 volts. Additional blanking circuits are required to eliminate the return traces which would otherwise be visible.

The images are photographed on ordinary positive movie film, resulting in a good contrast, positive image. The film is processed and is then ready for a regular theatre size projection machine. The time interval is not great, and among the advantages are large images with inexpensive equipment and the fact that the pictures may be repeated and duplicated.

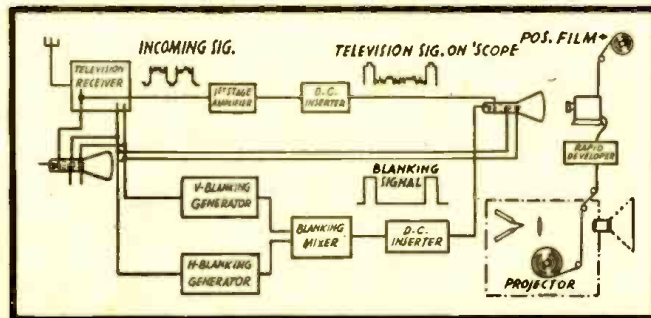

TUNING INDICATOR

Dermot Min Ambrose, London, England
Patent No. 2,377,475

A LAMP indicator is a simple and convenient means of showing the presence and power of an incoming signal, but usually requires relatively elaborate design to use. This circuit makes use of an indirectly heated, positive coefficient thermistor T to control the lamp L, so that the latter indicates the strength of a station.

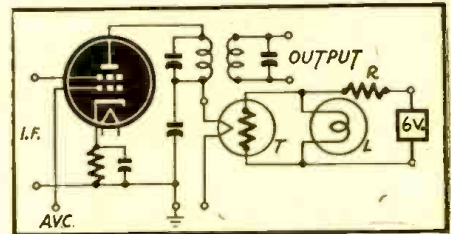

The figure shows an I.F. amplifier using separate grids for the signal and for the AVC, but conventional design may be used. The AVC is proportional to signal strength. As a station is tuned to resonance, a more negative potential is applied to the grid, thus decreasing the plate current. Since this current flows through the filament of the thermistor, the latter resistance decreases with signal strength, also.

The lamp circuit, which may be connected to a 6-volt transformer, is such that the lamp dims as the thermistor resistance lowers and vice versa. Therefore the system permits optimum tuning, and can be used to adjust for a station while the set is maintained in a quiet condition, such as by switching off the audio during the process.

VOLTAGE REGULATOR

C. W. Faulkner, Santa Monica, Calif.
Patent No. 2,373,750

VOLTAGE regulators usually include high current triodes which act as variable resistors, besides the usual rectifiers. This circuit uses triode rectifiers, thus combining the two functions.

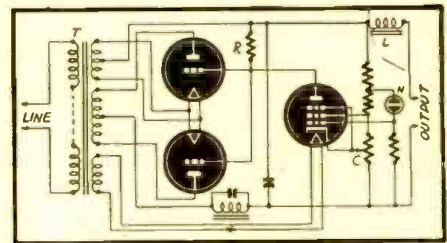

A bleeder is formed by the plate-cathode resistance of the pentode and the resistor R, to the junction of which the triode grids are attached. Effective resistance of the pentode is set by the potentiometer C, which varies its cathode potential with respect to the negative side of the line, and is also controlled by the No. 1 grid, attached to a point on a bleeder across the output.

As the load changes, the pentode grid voltage also varies with respect to its cathode. The neon bulb N tends to keep the voltage between grid and the positive power lead constant. A change of pentode plate current is thus produced, and this flowing through R, varies the grid voltage of the rectifiers, thus controlling the voltage output. The triodes may be capable of delivering 0-150 M.A., with a maximum voltage variation of one-half percent. C is the voltage adjustment.

WORLD-WIDE STATION LIST

(Continued from page 784)

7.120 GRM	LONDON, ENGLAND: Pacific service; 1:45 to 4:30 am.
7.150 GRT	LONDON, ENGLAND.
7.153 XGOY	CHUNGKING, CHINA: East Asia and South Seas beam; 7:35 to 9:40 am; North American beam; 9:45 to 11:40 am; European beam; 11:45 am to 12:30 pm; East Asia and South Seas beam; 12:30 to 1:45 pm.
7.160 HCIBF	QUITO, ECUADOR.
7.185 GRK	LONDON, ENGLAND.
7.190 COCG	HAVANA, CUBA: heard afternoons.
7.205 GWL	LONDON, ENGLAND.
7.205 EAQ	MADRID, SPAIN: heard 10:30 to 11 pm.
7.210 VLQ2	BRISBANE, AUSTRALIA: 3:30 to 9:30 am.
7.220 JCJC	CAIRO, EGYPT: 12:30 to 2 am; 6 to 11 am; noon to 5 pm.
7.230 GSW	LONDON, ENGLAND.
7.230 KWIX	SAN FRANCISCO, CALIFORNIA: Oriental beam; 7 to 9:45 am.
7.250 KGEX	SAN FRANCISCO, CALIFORNIA: Philippine beam; 6 to 10:45 am.
7.250 GWI	LONDON, ENGLAND: Near East beam; 3:30 to 5 pm.
7.257 JVV	TOKYO, JAPAN, heard at 2 pm.
7.260 GSU	LONDON, ENGLAND: North American beam; 5:15 pm to 12:45 am.
7.275 VUD8	DELHI, INDIA: 7 to 10 am; 12:15 to 4 pm; 9 to 9:30 pm; 9:35 to 10 pm.
7.280 GWN	LONDON, ENGLAND: African Service, midnight to 1:30 am.
7.290 VUD27	CALCUTTA, INDIA: Voice of Free India; heard at 8:30 to 9 pm.
7.305 VUD5	DELHI, INDIA: 9 to 10 am; 12:15 to 4:50 pm.
7.315 YSO	SAN SALVADOR, EL SALVADOR.
7.320 GRJ	LONDON, ENGLAND: Near East, midnight to 2 am; 1:30 to 5 pm; South America, 7 to 11:30 pm; Italy, midnight to 5 am; 1:30 to 5 pm.
7.370 KEQ	KAHUHU, HAWAII: heard at 3 pm.
7.380 NDN	U. S. NAVY AT GUAM.
7.380 HEK3	BERN, SWITZERLAND: off at 11 pm.
7.440 FG8AH	POINTE-A-PITRE, GUADELOUPE: 7 to 8:30 pm.
7.565 KNBA	SAN FRANCISCO, CALIFORNIA: Oriental beam; 5 to 10:45 am; East Indies beam; 11 am to noon.
7.575 KCBA	SAN FRANCISCO, CALIF.: East Indies beam; 5 am to 1 pm.
7.795 WVLC	PHILIPPINES-U.S. ARMY: heard at 4 to 4:30 am.
7.805 KNBX	SAN FRANCISCO, CALIFORNIA: Oriental beam; 5 to 10:40 am.
7.860 SUZ	CAIRO, EGYPT.
7.832 WLWS2	CINCINNATI, OHIO: South American beam; 8:45 to 8:30 am.
8.030 FXE	BEIRUT, LEBANON (SYRIA).
8.035 CNR	RABAT, MOROCCO: heard Sundays, 5 to 6 pm.
8.665 COJK	CAMAGUEY, CUBA.
8.696 COCO	HAVANA, CUBA: 8 am to 12:30 am.
8.830 COCQ	HAVANA, CUBA: 5:30 am to 1:30 am.
8.905 COKG	SANTIAGO, CUBA: 7:30 am to 11 pm.
8.960 APH	ALLIED HEADQUARTERS IN ITALY.

MAKING WARTIME ENGINEERS

(Continued from page 768)

activities, the school has been raised to the status of a department, and a considerable increase in its activities is envisaged. Naturally, the organization and methods employed in war-time are not necessarily those best suited to the needs of peace. Plans are afoot to house the school in its own establishment, and to enlarge its activities to include specialized training of existing staff enabling them to operate new and more complicated apparatus, e.g., for television, to institute refresher courses for older personnel, and to maintain a high standard of technical knowledge amongst the personnel of the Engineering Division.

The Engineering Training Department has its counterpart in the Program Division, which is concerned with teaching the technique of broadcasting drama, talks and music, and close cooperation is planned between the technical and non-technical departments in order to give the producer an appreciation of his medium, and the engineer an understanding of the problems and desires of the producer. The need for a full understanding of the problems of both divisions by their individual members will be self evident, but particularly is this true of the technician who is the liaison between the producer and the apparatus.



OSCILLOSCOPE CRO-3A

EVERY service man needs this portable oscilloscope for accurate and rapid service work on AM, FM and Television receivers. We list only a few of the many uses that make it indispensable in the modern service shop: study wave shapes and transients; measure modulation adjustment of transmitters; check receiver alignment; determine peak voltages; trace electronic tube characteristics. The CRO-3A gives a sharp, clear picture and is equipped with a screen for easy daylight viewing. Write today: *Specialty Division, Electronics Department, General Electric, Syracuse, New York.*

Electronic Measuring Instruments
GENERAL ELECTRIC
177-D4

Tone...

Always a Deciding Factor

In the selection of any musical instrument, tone is of vital importance. Cinaudagraph Speaker Engineers have kept pace with every tone advancement—pioneered many new developments. That's why you'll want tomorrow's, better than ever, Cinaudagraph Speakers in every fine receiver—every quality sound unit.



Cinaudagraph Speakers, Inc.
3911 S. Michigan Ave., Chicago
Export Div., 13 E. 40th St., New York 16, N. Y.

"No Finer Speaker in all the World"



PARTS?

ORDER TODAY FROM...

R. W. T.

WORLD'S LARGEST

Radio Supply House • Founded 1922

For Industrial Organizations
Laboratories • Purchasing Agents
Radio Dealers & Service Men
Training Schools • Expeditors
Amateur Operators and Experimenters

10,000 PARTS

Immediately available. (Some no longer
need priorities.) Selected and shipped
same day your order is received.

Radio Wire Television Inc.

100 SIXTH AVE. (DEPT. A-9) NEW YORK 13
BOSTON, MASS. NEWARK, N. J.

Originators of the

Lafayette Radio

soon in production again

DETECTOR CIRCUITS

(Continued from page 776)

ity of this circuit is much greater than that of the diode. This circuit may be adapted to pentodes as well as triodes but due to the high plate resistance of the pentode, impedance coupling is the most efficient method of coupling to a following stage.

At normal modulation and signal input values, distortion in the circuit will be due to the fact that during the positive portion of the input cycle the grid draws current. This also lowers the sensitivity of the circuit as well as the non-linear current change due to the positive voltage. This type of detection is often used in conjunction with regeneration for increased sensitivity.

The values for the grid leak and condenser are carefully proportioned in the same manner as in the diode detector. The normal value for the grid condenser varies between .0005 and .0025 mfd. and the grid leak will normally be found to have a resistance ranging from 100,000 ohms to 5 megohms.

Due to the fact that the grid detector operates without the benefit of any sort of fixed bias, its voltage handling qualities are much less than if the same tube were to be employed as a class-A amplifier. The maximum signal voltage that can be handled by the tube as a detector is approximately one-quarter of the voltage that could be applied to the tube in straight audio service with identical plate voltages. This factor will vary somewhat depending upon the amplification factor of the tube and the value of the grid leak and condenser.

CONTINUOUS-WAVE RECEPTION

Thus far, the detectors discussed are suitable only for the detection of modulated signals, but are impractical when it becomes necessary to detect intelligence which is

transmitted by continuous wave transmission, which is used in wireless telegraphy. This is true because an unmodulated carrier will only produce a D.C. voltage across the load resistor and this cannot be made to actuate an ordinary amplifier or a pair of headphones.

When it becomes necessary to receive unmodulated signals, the simplest method is by the use of the "beat note" or "heterodyne" principle. It is known that when two alternating signals are mixed there will appear in the output of the circuit two new frequencies which are equal to the sum and difference of the two original frequencies. When we apply this method to the detection of a radio signal we employ a local oscillator which is adjusted to a frequency slightly different from the frequency of the signal to be received. This signal from the local oscillator will produce (in the output of the mixer) two frequencies, one of which will be of a higher radio frequency and the other in the audio range. Since radio-telegraph signals are sent by starting and stopping the carrier, an audio note will be present in the output of the mixer when the carrier is being transmitted.

THE REGENERATIVE PRINCIPLE

Fig. 5 shows a grid detector to which has been added a coil which causes regenerative feedback and makes it possible for the tube to serve as the local oscillator. L1 and L2 serve as the conventional primary and secondary windings, respectively, while L3 is the "tickler" or feedback winding. The tickler is so connected that its voltage is in the proper phase to induce an additional voltage in the grid coil and thus increase the over-all amplification. The condenser C3 is used as the plate by-pass. When it is adjusted so that the tube is on the verge of oscillation, the tube is most sensitive as a de-



"It seems to be the coming thing!"

Suggested by: Name omitted,
Canton, N. Y.

detector of modulated signals. When the feedback voltage is increased further, oscillations will take place, and when these oscillations are at their weakest point, the circuit is most sensitive to the reception of unmodulated code signals. This is called a regenerative detector.

When the tube is oscillating weakly, a further increase of the feedback voltage will not increase the sensitivity but will actually make the circuit less sensitive to the reception of weak signals but will make the detector less prone to over-loading and will increase the signal handling capacity. This simple circuit has sufficient output to operate headphones and when it is well designed and operated, makes possible world-wide reception of short-wave signals.

One of the disadvantages of the regenerative detector is that when it is in the state of oscillation it acts as a miniature transmitter and re-radiates a signal into the antenna. This signal is capable of causing interference to receivers tuned to the same frequency for some distance. Such interference may be overcome by using a tuned amplifier stage between detector and antenna.

THE SUPER-REGENERATOR

While the regenerative detector is one of the most sensitive for the reception of short wave signals, it is not the best for ultra-high frequency reception because the circuit losses are very high and because of the fact that the amount of amplification is limited after the tube goes into oscillation.

If regeneration is increased far enough, the charge on the grid condenser cannot leak off through the grid leak resistor fast enough to follow the action of the signal voltage. When it is reduced, the grid condenser retains a large portion of its charge. Thus the bias of the tube increases and the amount of amplification is reduced until there is not enough feedback voltage to sustain oscillation. The oscillations then cease until the charge has leaked off of the condenser. This blocking is the result of the grid condenser-grid leak time constant.

The blocking action just described is called "quenching" or "squegging." This phenomenon, when properly applied, gives a tremendous increase in the gain of the regenerative detector. The grid leak resistor is increased above its normal value. The tube will be oscillating at a frequency which is due to the LC ratio of the tuned circuit, but these oscillations will be quenched or choked off at a frequency that is above the audio range and is determined by the RC time constant. During the time when the tube is not "quenched," the amplification builds up to an unbelievable degree. This quenching action causes a pronounced hiss in the output of the circuit when no signal is present in the input but will decrease in proportion to the strength of the signal being received.

When this action takes place in a circuit, it becomes a superregenerative detector. The selectivity of the input circuit is not as good as the straight regenerative type, but it is much less sensitive to ignition and other man-made types of interference due to its automatic volume control action, which makes the set most sensitive when a weak signal is being received. Thus noise pulses of the "shot" type are amplified much less than the signal and are less disagreeable. Due to the poor selectivity of this circuit, it makes a good cheap receiver of frequency-modulated signals. The more swing applied to the FM signal, the greater will be the audio voltage in the output of the detector.

REFERENCES:

Fundamentals of Radio, Jordan
Radio Engineering, Terman
Radiotron Designer's Handbook, Smith

Available for Prompt Delivery on Priority of AA3 or Better!

The New Model 450

TUBE TESTER



EXTRA SERVICE—The Model 450 may be used as an extremely sensitive Condenser Leakage Checker. A relaxation type oscillator incorporated in this model will detect leakages even when the frequency is one per minute.

The Model 450 comes housed in a portable leatherette covered cabinet complete with all operating instructions. Size 13" x 12" x 6". Net weight 8 pounds. Our Net Price

\$39⁵⁰

SUPERIOR INSTRUMENTS CO. Dept. R.C. 227 Fulton St., New York 7, N. Y.

SPEEDY OPERATION—assured by newly designed rotary selector switch which replaces the usual snap, toggle, or lever action switches.

Specifications:

- ★ Tests all tubes up to 117 Volts including 4, 5, 6, 7, 7L, Octals, Loctals, Bantam Junior, Peanut, Television, Magic Eye, Hearing Aid, Thyratrons, Single Ended, Floating Filament, Mercury Vapor Rectifiers, etc. Also Pilot Lights.
- ★ Tests by the well-established emission method for tube quality, directly read on the scale of the meter.
- ★ Tests shorts and leakages up to 3 Megohms in all tubes.
- ★ Tests leakages and shorts of any one element AGAINST all elements in all Tubes.
- ★ Tests BOTH plates in rectifiers.
- ★ Tests individual sections such as diodes, triodes, pentodes, etc., in multi-purpose tubes.
- ★ New type line voltage adjuster.
- ★ **NOISE TEST:** Tip jacks on front panel for plugging in either phones or external amplifier will detect microphonic tubes or noise due to faulty elements and loose internal connections.
- ★ Features an attractive etched panel.
- ★ Uses a 4½" square rugged meter.
- ★ Works on 90 to 125 Volts 60 Cycles A.C.



THERMOSTATIC METAL TYPE DELAY RELAYS PROVIDE DELAYS RANGING FROM 1 TO 120 SECONDS

Other important features include:—

1. Compensated for ambient temperature changes from -40° to 110°F.
2. Contact ratings up to 115V-10a AC.
3. Hermetically sealed — not affected by altitude, moisture or other climate changes. Explosion-proof.
4. Octal radio base for easy replacement.
5. Compact, light, rugged, inexpensive.
6. Circuits available: SPST Normally Open; SPST Normally Closed.

WHAT'S YOUR PROBLEM? Send for "Special Problem Sheet" and Descriptive Bulletin.

AMPERITE CO. 561 BROADWAY
NEW YORK 12, N. Y.

In Canada: Atlas Radio Corp., Ltd.
560 King St. W., Toronto

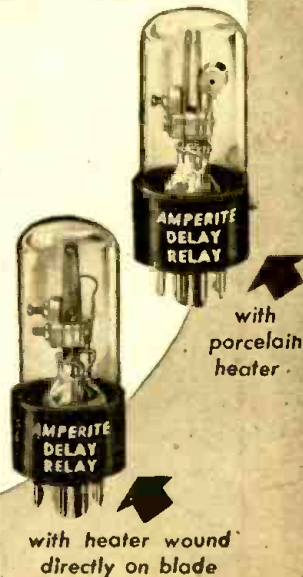

Amplifiers Intercoms Recorders



Write for Important New CONCORD Presentation

"Sound Equipment"—ready now—a new up-to-the-minute Concord folder illustrating and describing our complete line of Amplifiers, Intercoms and Recorders AVAILABLE FOR IMMEDIATE SHIPMENT.

Amplifiers—ranging in output ratings of 17 watts to the largest requirements. Complete listing of speakers, microphones and essential equipment also included.

Intercommunication Systems—with master and sub-stations for every purpose and need.

Recording Equipment—professional type for microphone recording, radio recording, transcriptions, public address.

Engineering Service—Our engineering service is at your command, without charge, to answer any and all "Sound Equipment" questions.

Mail the coupon below for your copy of "Sound Equipment" now.



CONCORD RADIO CORPORATION
Lafayette Radio Corporation
CHICAGO 7, ILL. ATLANTA 3, GA.
901 W. Jackson Blvd. 265 Peachtree Street

CONCORD RADIO CORP.
901 W. Jackson Blvd., Dept. RC-95
Chicago 7, Illinois

Please send me at once copy of your new "Sound Equipment" folder.

Name.....
Address.....
City..... State.....



Available Radio-Electronic Literature

Manufacturers' bulletins, catalogs and periodicals.

A NEW SERVICE FOR RADIO-CRAFT READERS: In order to save your time, postage and incidental work in writing a number of letters to different manufacturers to secure the various bulletins offered, proceed as follows:

On your letterhead (do not use postcards) ask us to send you the literature which you designate. It is only necessary to give us the numbers. We will then send your request directly to the manufacturers, who in turn will send their bulletins or other literature directly to you.

164—CATALOG 325.

Issued by Precision Scientific Company. Illustrated catalog of temperature controlled cabinets and electrically-heated ovens is offered by this company to manufacturers. 48 pages.—*Gratis to interested parties.*

165—MAGICORE. HIGH-FREQUENCY IRON CORES.

Issued by Henry L. Crowley & Company. This is a combined catalog and complete data book listing specifications on powdered iron cores for radio and electronic applications. Copies are available only to those actively engaged in designing and producing electronic equipment.—*Gratis*

166—HOW AND WHY CATHODE RAY TUBES WORK.

Issued by the North American Philips Co. A 16-page illustrated booklet telling the story of the Cathode-Ray tube and its applications. Written in engineerese, it is available to those interested.—*Gratis*

166-A—CAN ELECTRONICS IMPROVE YOUR PRODUCT?

Published by Operadio Manufacturing Company is a non-technical book designed to give executives and engineers a grasp of the possibilities of electronics in connection with their plants.—*Gratis to interested parties.*

167—INDUSTRIAL ELECTRONICS.

Published by General Electric Company. Publication No. GES-3303. This is a catalog describing a complete set of training material on Industrial Electronics and outlining a course composed of sound films and review books for use in training of personnel in electronics.—*Gratis to interested parties.*

168—COLOR CODE CHART.

Issued by the Stackpole Carbon Co. Of handy vest pocket size, these charts contain complete information on resistor color coding under the American War Standard specifications as well as the joint Army-Navy specifications, both being identical with the R.M.A. (Radio Manufacturer's Association) set-up.—*Gratis*

169—YOUR OPPORTUNITY IN THE NEW WORLD OF ELECTRONICS.

Published by Capitol Radio Engineering Institute. This revised booklet describes briefly the opportunities for professional radiomen in the fields of radio electronics. It covers the course given by this school, for both home and resident school study.—*Gratis*

170—THE TAYLOR TUBE CATALOG.

Contains full information on all tubes manufactured by this firm and includes some of the newer tubes now available and developed as a result of war demands. A large portion of the book is devoted entirely to tube characteristics.—*Price 25c*

171—FLUORESCENT AT ITS FINEST.

Presented by Sylvania Electric Products Co. A catalog on the latest fluorescent fixtures both for the home and industrial use.—*Gratis to interested parties.*

172—THE ABC OF LUMINESCENCE.

Published by the New Jersey Zinc Sales Company. This booklet discusses in clear simple language the characteristics, properties, limitations and applications of the inorganic luminescent pigments, as well as a glossary of the technical terms applicable to this industry.—*Gratis to interested parties.*

173—HIGH VOLTAGE TEST EQUIPMENT CATALOG BULLETIN F.

Published by the Shallcross Manufacturing Co. This bulletin describes several forms of high-voltage test equipment from portable Kilovoltmeters for use from 1 to 30 kilovolts to Corona Protected Kilovoltmeters for measurements up to 200 Kilovolts.—*Gratis to interested parties.*

174—TEN AND FIFTY KILOWATT TRANSMITTERS.

Published by Federal Telephone and Radio Corporation. Two catalogs covering low frequency and broadcast transmitters put out by this company for those interested in high power broadcast equipment.—*Gratis to interested parties.*

175—TRANSFORMERS AND CHOKES.

A 20-page catalog by Peerless Electrical Products Co., listing its available line. Included are power and audio transformers, autotransformers, equalizing equipment and other accessories. Two circuit diagrams illustrate the application of equalizers, and one page is devoted to power supply design including schematics.—*Gratis*

176—WAR SURPLUS, a catalog issued by Stark's, Chicago, Ill.

Includes a wide range of surplus government supplies, among which are a number of radio tubes, parts, etc. These include a few very-high-frequency tubes not commonly available before the war, and some aircraft meters with microammeter movements.

177—THE EFFECTIVE REPRODUCTION OF SPEECH.

Issued by the Jensen Mfg. Co. This is number 4 in the technical monograph series. It covers Frequency Ranges in Speech, Liminal Bands of Speech Reproduction, and The Spectrum of Speech, among other subjects. The past three issues in this series of four monographs have been listed in Available Literature.—*Price 25c.*

178—CETRON PHOTOTUBES.

Published by the Continental Electric Co. This catalog and data sheet covers the phototube and its applications as well as suitable circuits for it.—*Gratis to interested users.*

179—MUSIC AND MANPOWER.

Issued by Operadio Manufacturing Company. This illustrated folder covers the subject of industrial music and plant broadcasting.—*Gratis*

180—REGAN SPECIFICATION FOLDER.

Put out by the Techtmann Industries, Inc. This folder covers the specifications for Regan resistors and Radiant heaters.—*Gratis*

181—PUSH BUTTON UNITS, SELECTOR SWITCHES, INDICATING LIGHTS.

Published by General Electric Co. This is a catalog useful primarily to the manufacturer or purchasing agent. It describes the line of push button units, selector switches and indicating light units put out by this concern.—*Gratis*

ACCOUNTING IN THE RADIO SHOP

(Continued from page 767)

By judiciously checking the serviceman's daily record which includes home calls and shop activities alike, it can be determined which of your force are batting a relatively high efficiency average and, most important of all, the type of servicing at which they are relatively most or least efficient.

So much for records. The "balancing of the books" is a mathematical procedure if these records have been accurately maintained. If they have not, the services of the most highly trained accountant will prove of remarkably trivial value.

It should be unnecessary to add that all communications mailed to shop customers should be dispatched first class and not mimeographed or multi-graphed but personally typed. If form communications must be employed, utilize typewriter type. In general it is preferable to mail out 50 first-class epistles than 500 "waste-basket stuffers." Professionalism does not radiate from fourth or second class mailings. Avoid "Yours truly" endings—instead, substitute "Cordially" or "Sincerely." Bread and butter your letters—make them friendly but ration the sugary passages, for letter recipients have a cordial hatred for insincerity, no matter by whom issued.

Attention to good business methods spells success to the skilled radioserviceman.

RECEPTIONIST'S DAILY RECORD

On Duty at				
Off Duty at				
	Collected From	For	Amount	Time
1.	Mrs. Stanley Jones, 727 Boyd St., City	Radio Service	7.25	10:29 a.m.
2.	Mr. E. Gillette 4168 Grant Blvd., City	Kitchen Speaker	4.95	11:13 a.m.
3.	Miss Ethel Waters 111 Stone St., Utica	Antenna Kit	7.00	
4.		Ant. Erector	15.00	12:02 a.m.
5.				
6.				

In addition, each member of the repair staff should fill out a similar card showing his daily work schedule (i.e.).

On Duty at				
Off Duty at				
	Nature of Repairs	Price	Time Started	Time Completed
1.	Repaired Set (Appliance) belonging to John Reynolds of 710 Bay St., City	Faulty 27 tubes—burned out power transformer	6.25	8:05 9:10
2.				
3.				

HALLICRAFTERS ★ HALLICRAFTERS

RECEIVER HEADQUARTERS
for the Nation



BEFORE the war Bob Henry served the amateurs as the world's largest distributor of communications receivers.

Now Henry Radio is Hallicrafters receiver headquarters for the Nation at war. Hallicrafters Receivers can be supplied on priority. I can usually supply SX28As at \$223.00, S-39s at \$110.00, S20Rs at \$60.00, SX-25s at \$94.50, and PM-23 speakers at \$15.00 at once. It takes longer to supply other models.

Soon, it is hoped, non-priority orders can be filled and Bob Henry can become again Hallicrafters headquarters for the nation at peace.

I have stores at Butler, Missouri, and at 2335 Westwood Blvd., Los Angeles 25, Calif.

Your orders and inquiries are invited.

Bob Henry, W9ARA
HENRY RADIO SHOPS

Butler, Mo. and Los Angeles, 25, Calif.

COMPLETE STOCKS

I have in stock some Hallicrafters receivers available for immediate delivery on priority and the following parts without priority: meter rectifiers \$1.95; Trimm headsets, McElroy keys, bugs, oscillators, tubes, transformers, resistors, condensers, etc. Your orders and inquiries invited.

"WORLD'S LARGEST DISTRIBUTOR OF COMMUNICATIONS RECEIVERS"

Electricity

Models range from 350 to 25,000 watts, A. C. types from 115 to 660 volts, 50, 60, 180 cycles, single or three-phase and 400, 500 and 800 cycles, single phase, D. C. types from 6 to 4000 volts. Also available in dual voltage and special frequency types.



FOR RADIO AND ELECTRONIC APPLICATIONS

ONAN ELECTRIC GENERATING PLANTS supply reliable, economical electrical service for electronics and television applications as well as for scores of general uses. Driven by Onan-built, 4-cycle gasoline engines, these power units are of single-unit, compact design and sturdy construction. Suitable for mobile, stationary or emergency service.

Model shown is from W2C series; 2000 to 3500 watts; powered by Onan-built, two-cylinder, water-cooled engine.

D. W. ONAN AND SONS

2419 Royalston Avenue
Minneapolis 5 Minn.

Write For Folder 690-A describing complete Onan Line

SUPREME MODEL 504-A

**Tube Set
AND
TESTER...**

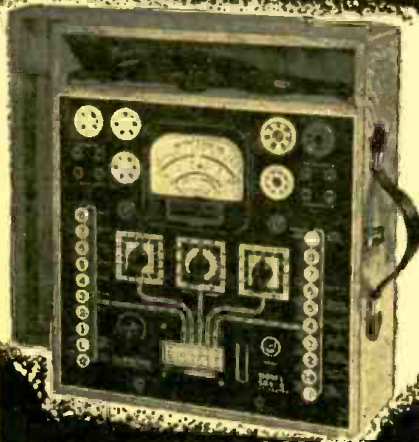

★ **THE PORTABLE LAB
THAT GIVES YOU
*Everything!***

- ★ Design proven by over 5 years production of thousands of this model.
- ★ Operation as simple as ABC. Multi-section push-button switches do all work. Simply "follow the arrows" for tube checking. No roaming test leads for the multimeter.
- ★ Open face wide scale 4 1/4-inch rugged meter built especially for this tester—500 microampere sensitivity.
- ★ Each AC and DC range individually calibrated.
- ★ Professional appearance. Solid golden oak carrying case.
- ★ Guaranteed Rectifier.

SPECIFICATIONS

DC MICROAMPERES: 0-500
 DC MILLIAMPERES: 0-2.5-10-50-250
 DC AMPERES: 0-1-10
 AC VOLTS—1000 OHMS PER VOLT:
 0-5-25-100-250-500-1000-2500
 OUTPUT VOLTS: 0-5-10-50-250-1000
 OHMMETER: 0-200-2000-20,000 OHMS
 0-2-20 MEGOHMS
 BATTERY TEST: Check Dry Portable "A" and "B" Batteries Under Load
 CONDENSER CHECK: Electrolytics checked on English Reading Scale at Rated Voltages of 25-50-100-200-250-300-450 volts.
 TUBE TESTER: Emission type with noise test floating filaments, PPSV Chart operation. Checks all receiving type tubes.
 POWER SUPPLY: 115 volts 60 cycle. Special voltage and frequency upon request.

The Cathode Ray Oscilloscope

YOU NEED THIS BOOK. "The Cathode Ray Oscilloscope," by Raymond Soward, fully explains basic operating principles of the oscilloscope. New, 25 pages, written in the Serviceman's language. Send 25c. to cover printing and handling costs, with coupon below.

SUPREME INSTRUMENTS CORPORATION,
 Greenwood, Miss.

I enclose herewith 25c. Please send me your new 25-page booklet, "The Cathode Ray Oscilloscope," by Raymond Soward.

Name.....
 Address.....
 City and State.....



French civilians "cannibalize" irreparable radios under direction of American sergeant.

Civilian-Military Service Station

THE U. S. Army's policy of employing civilian personnel wherever possible in its installations in France paid military dividends in the Signal Corps' largest salvage, repair and spare parts depot in the European Theater.

of the French resistance leaders. These men were parachuted into France months before the invasion.

One thousand French civilians were employed at the depot at its peak. In December 1944 the depot carried in stock 20,000 spare parts items, totaling 225 tons. By March of this year those figures had increased to 50,000 weighing 950 tons.



During the first three months of this year the soldier and civilian workmen completed 12,000 repair jobs despite the fact that an estimated nine out of every ten items sent back from the front had been so badly shot up that they were good for salvage of undamaged parts only.

Above—Handie-Talkie and receiver repairs. Below—Reclaiming used communication wire.

At the same time and up to V-E day, the Army's best team of crystal manufacturers were turning out 360 specially ground crystals a week. Activated last August, this group was made up of top-flight specialists and technicians drawn from the Signal Corps units throughout the Theater.

For example: The fifteen-man crystal team was the unit which made the special frequency crystals used in the radios



Chassis Cradle From Pipe Fittings

By WILLIAM LYON

THE sturdy chassis cradle illustrated permits working over a radio set with all wiring, etc., in full view, but without the usual hazard to tubes and other components. The rig can be quickly constructed.

All parts, including the "C" clamps, can be obtained from your local hardware-plumbing supply house. The lengths of pipe listed all come pre-threaded. The parts list follows: "A" is a twelve-inch length of pipe. Four required, "B" is a Tee. Three

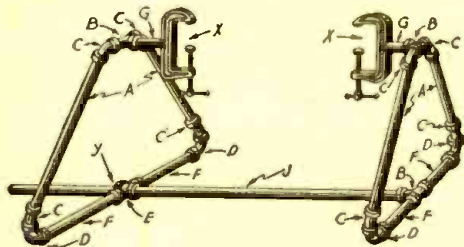

The chassis cradle above was built entirely of ready-cut, easily-obtained pipe fittings.

required. "C" is a 45-degree Street Elbow. Eight required. "D" is an Elbow (90 deg.). Four required. "E" is a Cross. One required. For "F" 4 nine-inch lengths of pipe. "G" requires 2 six-inch lengths of pipe. "J" as desired, but should be about twelve inches longer than the longest chassis you are accustomed to repairing. For convenience it might be well to have two different lengths. This is the one part that does not require to be rigidly tight. Thus it can be changed at will and permits easy "knock-down" when it isn't required on the bench. For "X" use two "C" clamps. These should be the five-

inch size, accommodating almost all chassis.

At point "Y" on the illustration it will be necessary to file down the thread with a large rat-tail file in one direction of the cross so that part "J" can ride through smoothly. By the same token there should be no thread on the free end of "J."

By making the sleeve "Y" smooth so that it slides easily over "J" but with no free play, a very rigid yet easily-adjusted cradle may be made. The chassis forms a top support when clamped in place, thus adding another brace. Thus it becomes unnecessary to secure "J" in any way, though the perfectionist may prefer to drill and tap "Y" for a set-screw.

One threaded end should be cut off "G" so that its over-all length will not be more than four inches. The unthreaded end should then have a slot cut in it to accommodate the web of the "C" clamp, as shown. The "C" clamp should then be welded into the slot. This operation is, perhaps, the only one you will not be able to accomplish alone. If you have no welding rig, you will probably be able to negotiate help from the local garage man who repairs broken automobile fenders. It will take him only a few minutes.

The most useful size for pipe and fittings should be from one to one and one-half inches. The "C" clamps should be installed in the positions shown in the illustration so that the clamping pressure will come up against the top of the inverted chassis.

I have found pipe fittings very useful in the radio shop. They come in a number of ready-cut lengths, which can be employed with elbows, bases for attachment to wood benches, and other fittings, to build up numerous handy devices.

RADIOMENS' HEADQUARTERS

BUFFALO RADIO SUPPLY

219-221 GENESEE ST., DEPT. C
BUFFALO 3, N. Y.

All purpose Neon Pocket Testers, 60 V. to 550 V. \$3.35 These testers indicate the kind of current, AC, DC, or RF, and come complete with a handy instruction booklet outlining various tests on radio sets, including the locating of fading, dead stages, and making screen grid and plate circuit tests.

Resistor Assortments: 50 2-Watt—1.95; 200—1/2-Watt Carbon—\$4.50; 200—1/2-Watt Insulated—\$5.00. We also have a 10-Watt Wire Wound, 525 ohm tapped at 250. Can be used as a 125 ohm in Parallel, or as a 250 or 275 ohm. Perfect for tube substitutions. \$1.10 each.

Beautiful Silver-tone Modern Walnut Cabinets in original cartons. Large enough for most chassis and only \$1.50 each. Model No. 4619, with glass & plastic escutcheon—9x10 1/2 x 16 1/2 high; or No. 1923—11x18x20 high.

Special on Permanent Magnet Speakers: 2 1/2"—\$1.75; 4"—\$1.75; 5"—\$1.75; 6"—\$1.95; 8"—\$4.25; 10"—\$6.00; 12" (21 oz. magnet)—\$8.00.

ALL TYPES OF RADIO TUBES IN STOCK ALMOST ALL THE TIME!!!! MAIL IN YOUR ORDERS FOR ALL TYPES NEEDED NOT JUST THE CRITICAL NUMBERS, AND WE'LL TRY TO FILL THEM COMPLETELY. WE ALSO HAVE ALL KINDS OF BALLAST TUBES IN STOCK. Perfect 2525 and 2526 replacements in stock listing for \$2.80. No resistors, no rewiring, cost you \$1.00 each! Silver-tone 1A2 ballasts or RCA UX200 (replace 71A)—\$3.10 each. All adaptors, including resistor type, \$5.00 or \$1.00 for \$5.50. Unwired adaptors, octal or local to octal—20c.

3 Gang Tuning Condensers \$3.60
2 Gang Tuning Condensers, Superhet or Plain, \$3.85
GTC Powerpacs furnish complete A & B power to electrically all battery portables with from 4 to 7 tubes from 110V, 60 cycle. Just plug the battery connectors in the universal outlets on the side of the 2 1/2 x 4 1/2 x 6 3/4 pack. A great buy. Complete, only \$9.90.

While they last, the following tubes with list prices as indicated, cost you only \$4.99 each: 12SF—\$1.10; 6SC7—\$1.30; 217—\$1.30; 6CB6—\$1.60; 6BB6G (replaces 6G7)—\$1.30; 6SN7—\$1.30; 39/44—\$1.00; 6SD7 (repl. 6SK7, 6SJ7)—\$1.30.

Guaranteed Tubular Condensers: 8 mfd. 450 V.—\$3.35; 20/20 mfd. 150 V.—\$3.35; 20 mfd. 150 V.—\$2.25; 10 mfd. 150 V.—\$1.18; 25 mfd. 600 V.—\$2.20; 1 mfd. 600 V.—\$1.10. All smaller capacities in 600 V. rating cost you \$1.10 each.

"Bullet" Crystal Microphones with 7' Shielded Lead, \$5.45. "Bullet" Dynamic Microphones with 7' Shielded Lead, \$7.45.

Double phone or mike plugs, red or black barrels, \$3.27. First Grade Needle Point Test Prods \$4.45 per pair. Free Stroboscope with each order while supply lasts.

COMPLETE STOCKS—50% deposit on COD orders—FAST SERVICE. Put "L265", the radioman's priority symbol, above signature on order.

PRACTICAL HOME-STUDY RADIO COURSE

These men used this course to get into good radio jobs



FINEST TRAINING COURSE USED IN MANY SCHOOLS

"The radio training course is the finest up to date easy to understand course. . . . This course outlines practical work. We are using this course in our Topeka High School. It is wonderful." *Henry Ward, Jr., 622 Filmore St., Topeka, Kans.*



WORTH MUCH MORE

"You should get more money for your Course. The first week I studied it, I made \$10.00 repairing sets. I built my own test outfit from details given in this course. I have repaired 100 radios to date. Signed: *Robert C. Hammel, 120 W. 13th, Davenport, Iowa.*



COMPLETED IN 8 WEEKS

"I am very satisfied with the course. When I was at the twelfth lesson I started repairing radios. It took me two months to master your course." From a letter written by *Roger Lanzlois, 1679 Poupart, Montreal, Canada.*



MODERN, UP-TO-DATE

"I have found since taking your course how modern and up to date it really is. There is not one page in the whole course which anyone interested in radio can afford to miss. Your course started me on the road to a well paid job and has repaid me many times." *Charles Alpach, 433 Elm St., Reading, Pa.*

AMAZING BARGAIN OFFER

In this large course-manual of 22 practical lessons, you have all the topics covered by the best \$100.00 radio correspondence course. Learn important fundamentals. Speed-up radio servicing. Includes hundreds of circuits, thousands of repair hints, many servicing short-cuts.

RADIO TRAINING FOR HOME-STUDY

This practical home-study course will show you how to repair all types of sets faster and better, tell you how to open your own shop and run the business. The lessons are well illustrated, interesting to read, easy to understand and apply. No special previous knowledge is needed. The early lessons explain important principles. Other lessons cover test equipment, trouble-shooting, circuit tracing, television, and every other important topic of radio and electronics.

SERVICING METHODS SIMPLIFIED

Learn new speed-tricks for radio fault-finding, case histories, servicing short-cuts, extra profit ideas. Included are many large lessons on the use of regular test equipment, explanation of signal tracing, oscilloscope, transmitters, P.A., television, recorders. Let this information save for you enough time on a single job to pay the full price of \$2.50 for the complete course of 22 money-making lessons.

A PARTIAL LIST OF TOPICS COVERED

Circuits, Auto sets, P.A., Tube Characteristics, A.C., Fidelity, Using charts, Amplifiers, Tracking, I.F., Phase, Reactance, Impedance, Modulation, A.V.C., Photo-cell, Review questions, Crystals, Test equipment, Meters, Analyzers, Tube testers, Signal tracing, Oscilloscope, Ohm meters, Accuracy, Graphs, and hundreds of other topics.



IN MANUAL FORM

\$2.50
COMPLETE

SPECIAL OFFER
READ THE DETAILS

EASY TO UNDERSTAND AND APPLY

The practical lessons makes up this course-book are easy to follow and apply to actual radio jobs. Hundreds of radio facts that puzzled you will be quickly cleared up. You will find yourself doing radio repairs in minutes instead of hours—quickly finding the faults or making needed adjustments. Every new radio development of importance and thousands of time-saving radio facts are packed into this complete course-manual.

SATISFACTION GUARANTEED

Use coupon to order the Course for 10-day examination in your own home. Look over the material, read a few lessons, apply some of the ideas. Then decide to keep the lessons at the bargain price of \$2.50 (full price), or return the material and get a cash refund.

NO RISK TRIAL COUPON

SUPREME PUBLICATIONS, 9 S. Kedzie Ave., Chicago 12, ILL.
Ship the complete Radio Course for 10 days use. I must be satisfied or you will refund my money.

- I am enclosing \$2.50, full price. Send postfree.
 Send C.O.D. I am enclosing \$..... deposit.

Name:RCS

Address:
(Use Coupon or Write Order in a Separate Letter)



So much for so little

● A mere handful of these Aero-vox war-time capacitor replacements can take care of upwards of 90% of your usual capacitor replacements. Only nine selected values for the "Dandee" electrolytics, only eight capacitance values, all 600-volt, for the paper tubulars, will do the trick. Keep a supply on hand to handle those RUSH jobs.

● Ask Our Jobber . . .

Ask him for an assortment of Aero-vox "Dandees" and paper tubulars. Ask for latest catalog, or write us direct.

AEROVOX Capacitors INDIVIDUALLY TESTED AEROVOX CORP., NEW BEDFORD, MASS., U. S. A. In Canada: AEROVOX CANADA LTD., HAMILTON, ONT. Export: 13 E. 40 ST., NEW YORK 16, N. Y. Cable: 'ARLAB'

Tracer with Triode Probe

By D. T. MOORE

THIS instrument is essentially a high gain amplifier for signal tracing both aurally and visually, and is designed along conventional lines. It differs in that it uses a triode probe in place of the more conventional diode types ordinarily in use.

By using a series of these amplifiers and omitting the output stage in all but one of the amplifiers, the instrument may be used for multiple-channel signal tracing. The probe grids may be connected into the path of the signal and, by injecting a constant modulated signal and adjusting the volume controls, intermittent operation may be detected. The volume controls are adjusted until the eye is barely closed. If a component part breaks down, it will be indicated by the eye.

A feature of this unit is that although the amplifiers may be built on the same chassis and use a common power supply, there is very little interaction. If four or five units are used from the same power supply a heavy-duty power transformer sufficient to handle the load should be used. A switching arrangement could be employed to cut out the channels not in use.

When checking signal quality, tune in a good local station, close switch No. 2 which connects the output stage and speaker into the circuit, and connect the shield of the probe to ground or chassis. The tip of the probe is then applied to the grid of the first R.F. tube. A signal should be heard. Then proceed from there to the plate and so on down the line through the set until the trouble is located. Reduce the gain control on the tracer as you proceed toward the speaker. By injecting a modulated signal at a constant level, a fair idea of the stage gain can be obtained by observing the 6E5 tube and proceeding as already outlined above.

This tracer can also be used as an output indicator by simply placing the test probe near the output tube of the set being aligned and observing the 6E5, retarding the volume control as the set comes into alignment. A very small signal from a signal generator will give a good indication. Phonograph crystals can be checked with the tracer by connecting the ground lead to the ground lead of the crystal, and touching the probe lead to the other crystal connection. The crystal will oscillate and this will be indicated by the closing of the eye. If the speaker is thrown into the circuit during this test, a loud squeal will

imagination to build anything today, the shortage of parts being what it is. One way to do it, is to cut a piece of tin long enough to accommodate the condenser, grid resistor and the 6F5 tube, and wide enough to slight-

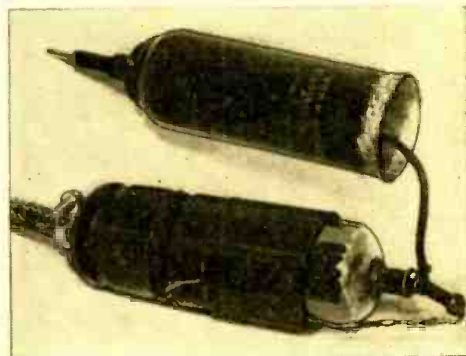

Triode probe open. Attached to grid-cap is a 2-meg. resistor. Condenser is near the tip.

ly overlap itself when bent snugly around the tube base. After taping securely, the shield is soldered together and another small piece of tin is soldered to the end to form a cap. This end is used for the probe tip. When alligator leads are used in place of the probe tips, the wire should be not more than 3 or 4 inches long. The grid resistor can be any value from .5 to 2 megohms. If the metal shielding for the probe cable is not available, a single shielded wire can be used for the plate lead and the



Case of probe is made from old metal tubes.

shield grounded. This would leave one wire outside the shield, but it could be taped to the shield at short intervals. The probe cable can be of any length.

The front panel may be made from masonite, bakelite, or other similar material. The sub-panel can be of either metal or bakelite. The size of the panel and sub-panel will have to be determined by the constructor depending on the number of chan-

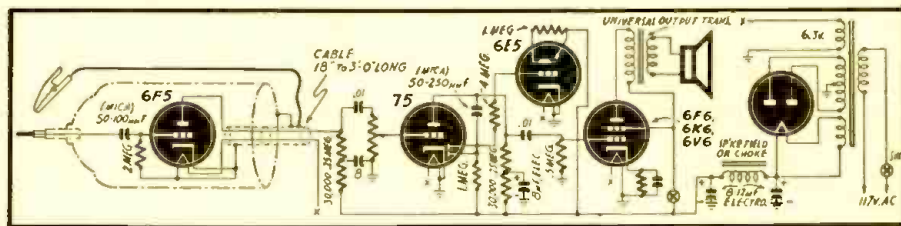

The complete Signal Tracer. A switch is provided so either 6E5 or speaker can be used.

be heard. This test must be conducted with the crystal on the work bench or other insulating material, but not held in your hands, as it will not work that way.

The probe can be constructed from anything from bicycle grease guns to pieces of tin cut from ordinary tin cans. The one shown in the photo was made from a metal tube. The constructor will have to lean heavily on the good old junk box and his

nels he decided to build.

Channels 1, 2, 3, and 4 consist of a 6F5, 6E5 and a 75. Channel No. 5 consists of the entire schematic.

The tuning eye mounting assemblies can be salvaged from discarded broadcast receivers, or, where this is not possible, the constructor will have to fashion brackets and mount them to suit his taste or the individual circumstances.

SUBSTITUTE FOR 35Z5'S

By GERRY L. GAYDO*

ALTHOUGH this substitute for the 35Z5 is not practical economically, it is much easier to build it than to get a 35Z5.

The substitute was made up of three 12H6's and the base from a bad octal tube. The 12H6's are very easy to obtain. In fact, they may be found in any radio retail or wholesale house.

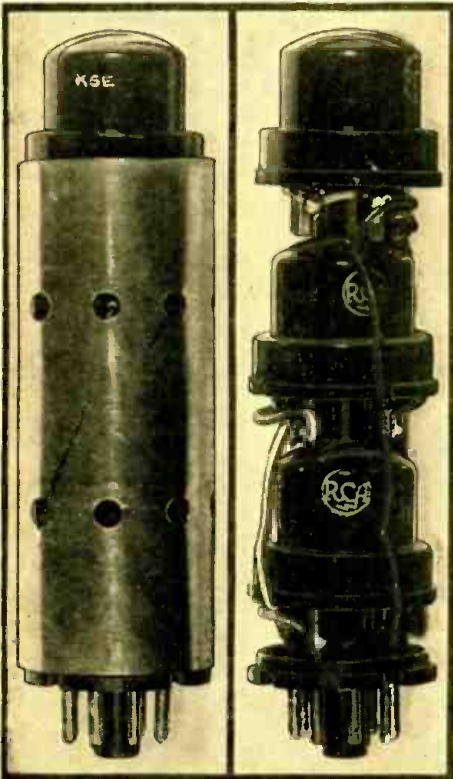

The composite tube, in and out of its shield.

The first of these built was much too long and clumsy. This was overcome by grinding the pins of the 12H6's down a quarter of an inch. Also, the base of a metal octal tube was used the second time instead of the base from a glass tube. The length of the pins after being ground down can be seen in above photo, right.

Because the tube did not look so well just as built, a covering was placed around it. This covering was made of thin sheet metal and perforated to give ventilation. The sheet metal was cut to the right size, rounded to fit the tube and then soldered.

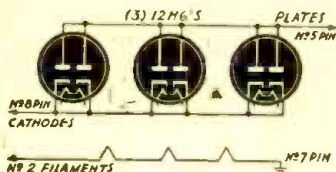

The substitute has been proven to have characteristics as good as the 35Z5 and possibly better. First of all, it was checked on the tube checker, using 35Z5 control settings. This check gave a higher reading than the 35Z5. The substitute was also put on a hundred-hour check in a five-tube superheterodyne. The tubes in the superheterodyne were drawing a total of 91.4 mils. At the end of this hundred hour check, the tube still gave maximum operation.

The circuit for this substitute is illustrated herewith.

*United States Marine Corps.

SPEED UP REPAIRS WITH THESE G-C AIDS!



FREE STEEL CABINET

Get This New FREE Dial Belt — Drive Cable and Cabinet Repair Guide!



G-C DIAL BELT KITS

Exact replacement woven fabric belts. Easy to install —no stretching—no adjustments—a perfect fit everytime. Kits come with 25, 50, 100, 200 or 300 belts.

Pocket size 68 page book contains thousands of listings, specifications —time saving service instructions. Invaluable to every radio man. Get a copy from your jobber. If he cannot supply you, write us.

Immediate delivery on G-C Belts and Cables

Order From Your Radio Parts Jobber
ALWAYS ASK FOR G-C PRODUCTS



GENERAL CEMENT MFG. CO.
ROCKFORD, ILLINOIS

ENGINEERS! DRAFTSMEN! ACCOUNTANTS! STUDENTS!

This Remarkable New Slide Rule

ORDER TODAY! Sensational NEW
MULTI Slide Rule



Clear, legible print . . . Tough, durable for long wear . . . Size 10" x 4" . . . Fits 3-ring binder . . . In case . . . Full instructions . . . TRANSPARENT PLASTIC INDICATOR

greatly simplifies calculation of unlimited range of problems!

Note these 8 New Features!

In addition to having ALL the values of the ordinary slide-rule, the new Multi-Slide Rule has:

- 1 Four-place LOGARITHM TABLE
- 2 SIGNS and LIMITS of VALUE assumed by trigonometric functions
- 3 Table of NATURAL TRIGONOMETRIC FUNCTIONS
- 4 Table of TRIGONOMETRIC FORMULAE
- 5 Table of SLIDE-RULE SETTINGS
- 6 Table of GENERAL EQUATIONS
- 7 Long list of common MATHEMATICAL FORMULAE
- 8 DECIMAL equivalents of a fraction

NOW AVAILABLE
at our stores:—

—BRANCHES—

PHILADELPHIA: 3145 N. Broad St., 5135 Market St.
ALLENTOWN, PA.: 1042 Hamilton St.
CAMDEN, N. J.: 513 Cooper St.
WILMINGTON, DEL.: 219 W. 8th St.

RADIO ELECTRIC SERVICE CO. of PA.

701 ARCH STREET PHILADELPHIA 6, PA.

Television in hotel rooms is the No. 1 new feature desired by guests in the post-war period, according to a survey conducted last month by Frank L. Andrews, president of the Hotel New Yorker. Seventy-one percent of the guests replying to a questionnaire wanted televisers. Even larger percentages voted in favor of other features, which however, were mere restoration of pre-war practice or improvements on present conditions.

MANUFACTURERS! ARE YOU INTERESTED IN INCREASING YOUR EXPORT SALES?

We are seeking additional lines for export representation either on a commission basis or can purchase for our own account paying you cash in New York funds. We handle all correspondence, paper work, details. Write Box T

The RADELMA Company
53 Park Place New York City 7

TRANSISTOR

1700

ANSWERS



TO YOUR HARDEST PROBLEMS

1178 Illustrations
1000 Pages
130 Tables — 105 Graphs

GET THE ANSWERS NOW!

Here, in one big volume, you'll find all the time saving answers to your radio problems... and time saved is MONEY EARNED. Written in easily understood language, yet accurate enough for an engineer. Completely revised and cross indexed for quick reference, this handy reference book for your tough jobs covers radio transmission and reception, public address systems, television, photocells and data on their important parts. It's a book you'll always use. And... it's only **\$5.00**

ANOTHER TIME SAVING BOOK!

ELECTRICAL AND RADIO DICTIONARY. Over 3800 definitions of technical words and terms used in all branches of radio and electricity. 300 Pages—350 Illustrations..... **\$2.50**

CLIP COUPON NOW!

GATEWAY BOOK COMPANY
32 N. State, Chicago 2, Ill.

Please send the books I've checked C.O.D. Satisfaction guaranteed or money refunded.

Drake Cyclopedic Radio Dictionary

NAME

ADDRESS

CITY STATE

KELNOR
REG. U. S. PAT. OFF.

electric SOLDERING IRONS



AMERICA'S
FINEST LINE
OF LIGHTWEIGHT
IRONS

PATENTS
GRANTED,
APP. FOR

Designed for
most efficient
soldering in the

**ELECTRONIC,
RADIO AND
INSTRUMENT
manufacturing and
repairing fields**

Easily solders hard-to-reach connections. Cuts down fatigue, increases accuracy. Illustration above about one-third actual size; weighs 9 ounces. Order from your retailer or jobber.

KELNOR MANUFACTURING COMPANY
GENERAL OFFICES: CENTRAL TOWER, SAN FRANCISCO 3, CALIF.

Transconductance Tester

By HYMAN HERMAN

AFTER studying many tube testers and characteristic charts, I have designed and built a checker that is very flexible, simple to operate, and should never become obsolete. I have compared tubes tested on my instrument with expensive commercial instruments and it has never failed to check as good as the commercial tester.

A chart can be prepared by the user, or readings can be noted in the tube manual. All voltages used, with the exception of the filament, are constant. The only other adjustment is the variable shunt across the meter, so that all readings can be on the right side of the meter dial.

T₁ filament transformer was made from an old power transformer. All windings were removed, with the exception of the A.C. primary. While taking off the 5-volt winding I counted the turns per volt. That is to say, if there are 20 turns on the 5-volt winding, that would mean that there are four turns per volt. A 6-volt winding would require 24 turns of the same size wire, a

A numbered scale marked from 0 to 100 for 270 degrees of rotation is used for the shunt setting. The setting for each tube, once found, can then be marked in the tube manual for future reference.

In testing tubes, the tube manual is first referred to for characteristics and element connection. I use the column headed "plate current Ma.," and judge where to place my variable shunt. When using an 0-5 milliammeter, the shunt would not be used if the tube being tested would draw 4 Ma. When testing a tube drawing, say, 8 Ma., the resistor is set to multiply the meter to a 0-10 Ma. range. If a tube draws 40 Ma., the meter is multiplied to the 0-50 Ma. range, etc. An 0-5 Ma. meter would be most suitable as it would permit the reading of tubes drawing only about 3 or 4 Ma. The resistances of the shunts will depend on the range of the meter.

As an example of how this unit works, let us suppose that you wanted to test a 12SQ7. Jack 1 is placed in the shield plug.

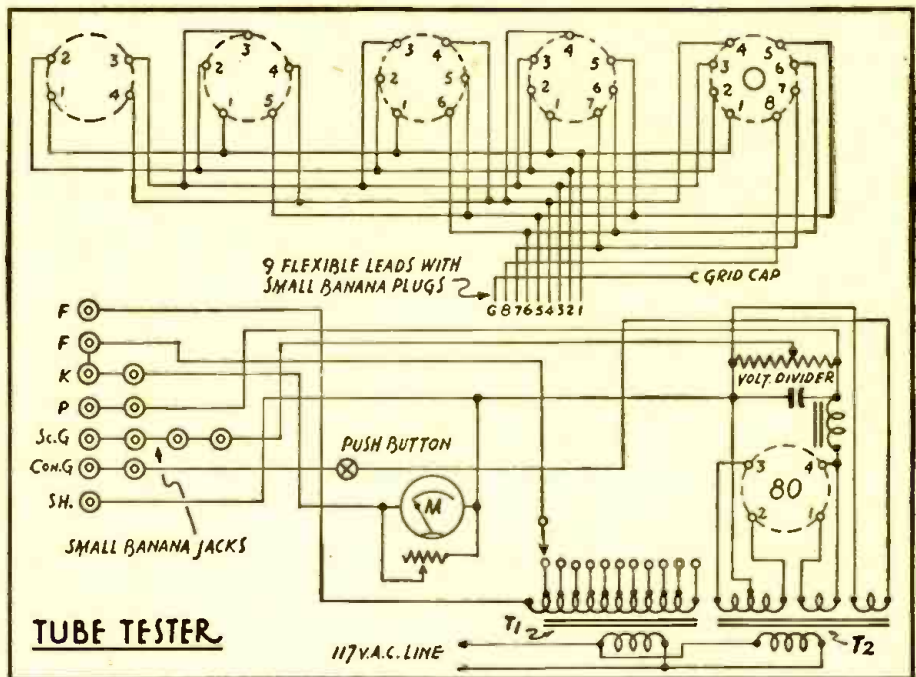

2-volt winding would require eight turns, etc.

The new filament winding was made with No. 20 enamelled wire, making provision for taps at 1.5, 2.5, 3.5, 5, 6.5, 7.5, 12.5, 25, 35, 50, 70, 117 volts.

T₂ is used to supply the B voltage. The 2.5-volt winding is used to supply the control grid with an A.C. signal voltage. Small banana plugs and jacks are used to make the connection between the tube elements and the various voltages.

The constant use of this instrument will enable the serviceman to become thoroughly familiar with the position of the elements in the various tubes. Regardless of where the elements are placed in future types, this arrangement will make it possible to test those tubes. If they have more than nine terminals, all that will be needed is an extra banana plug. Additional closed-circuit push-buttons can be added into any of the other leads to observe the action of the various elements. The push-button in the control-grid lead will enable you to see the grid swing, or the effect of the A.C. voltage on the control grid element.

Jack 2 is placed in the control grid plug. Jack 3 is inserted in the cathode plug. Jack 4 and jack 5 go into the screen grid plug. Jack 6 is connected into the plate plug. Jacks 7 and 8 are put into the filament jacks. The filament switch is set at the 12.5-volt position. When the A.C. switch is turned on, the 0-10 milliammeter will go off the scale. The variable shunt across the meter will set the pointer at a predetermined point on the dial scale. Removing jacks 2 and 6 will give you the diode plate readings. These can also be tested individually by removing either jack 4 or jack 5.

An electric guitar which doubles as a radio receiver is the property of June Foote, Greentree, Penna. Discovering its peculiar properties by accident when putting away her guitar one evening, she now simply loosens the plug to the amplifier slightly. The apparatus then functions as an imperfect-contact detector (Foxhole Emergency Radios, *Radio-Craft*, September, 1944) and brings in the stronger programs with excellent quality.

TECHNOTES

ATTENTION, SERVICEMEN!

Do you have any servicing notes available which you would like to bring to the attention of the readers of *Radio-Craft*? If so, send them along. If they are publishable a six-month subscription to *Radio-Craft* will be awarded you. If your notes are illustrated you will be given a one-year subscription.

... 6A8-6K8 SUBSTITUTE

Here is a service hint that has helped me. Pentagrid convertors such as the 6A8 and 6K8 have become as scarce as hen's teeth around here. With the following changes I have been using 6L7's instead, as they are more plentiful.

1. Remove anode grid connection from No. 6 pin and connect to No. 4 pin.
2. Remove oscillator grid connection from No. 5 pin and connect to grid cap of 6L7.
3. Connect antenna section of tuning condenser to No. 5 pin instead of former grid cap.
4. Realign.

I have made about 100 replacements in this manner and haven't had a come-back. In fact, the result is just as good as the original 6A8 or 6K8.

S. H. BEARD
Sheffield, Alabama

... VICTORETTE, VICTOR ACE AND MASCOT

The circuits of these are practically identical. The fly in the ointment is the extremely low quality of components, particularly the by-pass condensers. Every one reaching our shop requires two or three by-pass or coupling condensers to be replaced, and if the set has been intermittent, all of them are to be replaced.

THOMAS C. RUMNEY
Toronto, Ontario

... SPEED ADAPTER

When making tube substitutions, an excellent idea is to take an octal socket and connect insulated leads to the bottom lugs, soldering tube prongs on the other end of the leads. The prongs could be cut from an old tube, and the leads should be about six inches long. When trying a substitute tube, insert the tube into the octal socket and the prongs into the receiver tube socket in their proper positions. By doing this you are saved the trouble of making an adapter each time and then finding that it will not work in the particular circuit you intend to use. Several of these may be made, using one of each different type tube socket.

G. W. BATEMAN
Port Arthur, Texas

... AIRLINE 62-555

Dead. Tubes check O.K. and voltage is present. Audio stages in working order. Turn volume on full and set dial at a local station. Momentarily short B plus to chassis. If there is loud playing for a moment, the 1A7 is probably weak. In many of these sets, if the first detector is slightly weak, it will refuse to oscillate. If a new 1A7 cannot be purchased, it may be replaced by a 1R5 and a suitable adaptor.

RICHARD L. ALLMAN,
San Francisco, Calif.

... SILVERTONE MODEL 2541

I have had several of these sets come into my shop with an open first I.F. transformer primary. This is a special transformer

with a .00025-by-pass condenser and a 15-megohm resistor built in to it. I used a coil assembly from another 456 I.F. transformer and installed it. Rebalanced the set and the job was completed.

J. H. DEW
Nixon, Texas

... RCA T-10-1

No signals get through any band, but oscillator is O.K. Tunable hum. The grid leak has increased in value and the circuit blocks. On these sets, the grid leak is above chassis and can be replaced without removing the set from the cabinet. The AVC blocking condenser usually is shorted in this case. This results in distortion with increased signal or perhaps complete cut-off on a local station.

CHARLES McCLESKEY, JR.
Baton Rouge, La.

... I.F. REPAIR

Recently I had a set to service with an I.F. transformer that had been tampered with. Not having an oscillator at the time, I hit upon a novel idea. I happened to have a set with I.F. transformers of the same frequency and already peaked. I disconnected the diode and plate leads of the I.F. in the ailing set and connected the peaked I.F. transformer in place of the original one, letting it hang under the chassis. I then proceeded to peak the first I.F. to this peaked 2nd I.F. Following this, I disconnected the borrowed I.F. transformer and connected the diode and plate leads back in their original places. I then peaked the 2nd I.F. (that had just been connected back into the circuit), to the first I.F. This completed the job satisfactorily to myself and the customer.

DONALD SERRA
Boston, Mass.

... ZENITH 10S669

We find this model coming in frequently as a weak set, all preliminary tests normal. When grid of 6A8 is touched, volume increases appreciably. Removing the 7G7 R.F. preselector does not change the volume any. Voltage checks show plate to be normal and screen to be below normal for that tube. This is caused by a high leakage path to ground through C6 (.05 by-pass condenser). Have found these condensers to have resistances as low as 9000 ohms. Replace with new .05 at 600-volt rating.

A. DRESSLER
Millersburg, Pa.

... STEWART WARNER R-120

Distortion at all volume levels. All voltages appear normal. Double check will show I.F. screen to be low by 2 to 3 volts. Check .5 mfd. condenser from screen to ground for leakage. Leakage of 1 meg. will cause above trouble.

Remedy: Replace with a 600 volt condenser.

WILLIAM PORTER
Los Angeles, Calif.

One Central Source FOR Everything in RADIO and ELECTRONICS



FREE Helpful BUYING GUIDE

LARGEST STOCKS
COMPLETE SERVICE

REPAIR and REPLACEMENT PARTS AVAILABLE without priority

Over 10,000 items from all leading manufacturers... for the Armed Forces, Radio Training, Laboratories, Industry, Service Replacements.

New Parallel Resistance and Series Capacitance

CALCULATOR

Solves every-day problems - quickly!
No. X37-960

Postpaid ... 25c



R. F. Resonance and Coil Winding CALCULATOR

No. 37-955
Postpaid ... 25c

6 Radio Books for 75c

Dictionary of Radio Terms. No. 37-751 10c
Radio Data Handbook. No. 37-754 25c

Radio Circuit Handbook. No. 37-753 10c
Radio Builders Handbook. No. 37-750 10c

Radio Formulas & Data Book. No. 37-752 10c
Simplified Radio Servicing. No. 37-755 10c

All Six Books No. 37-799 ... 75c

Write for Quantity Prices

ALLIED RADIO CORP., Dept. 2-J-5
833 W. Jackson Blvd., Chicago 7, Ill.

Please send following (enclosed)

- FREE Guide 37-750 37-752 37-754
 Calculator 37-955 37-751 37-753 37-755
 Calculator X37-960 No. 37-799 (All 6 Books)

Name.....

Address.....

City.....State.....

ALLIED RADIO

Learn RADIO-ELECTRONICS-TELEVISION



12 WEEKS TRAINING IN COYNE SHOPS WHERE YOU "LEARN-BY-DOING"

Trained Radio-Electronics men needed now. They will be needed too when the war is over. Tremendous expansion in Radio, Electronics, Frequency Modulation and Television predicted—a world of new opportunities. Get Radio Training in the Coyne Shops in Chicago now, and BE READY.

Ill Finance Your Training

If you are short of money, you can start now and pay most of your tuition after you graduate. Many earn while learning. Free Lifetime Employment Service to graduates. EXTRA training in INDUSTRIAL ELECTRONICS and Electric Refrigeration—no extra cost.

FREE BOOK
Whether you're 16 or up to 40, get the facts. Big illustrated book tells about your future in Radio-Electronics-Television. Mail coupon today. We also have facilities for men with physical disabilities whether due to war or other causes. Check coupon for details.

VETERANS
Coyne is equipped to train those who qualify for training under the G. I. Bill of Rights. Check coupon.

H. C. LEWIS, Pres., RADIO-ELECTRONICS DIVISION
COYNE ELECTRICAL SCHOOL
500 S. Paulina St., Dept. 65-8H, Chicago 12, Illinois
Send me FREE BOOK on COYNE RADIO-ELECTRONICS TRAINING and details of "Pay-After-Graduation" Plan. Send physical disability details. Send special G. I. Bulletin.

NAME.....
ADDRESS.....
CITY..... STATE.....

FREE TO RADIO MEN

COLOR CODE and OHMS LAW CALCULATOR

Burstein-Applebee of Kansas City offers you this great convenience FREE. Easy to work. Solves many problems in a jiffy. FREE to radio men, electronic engineers and others in the business. Attach coupon to your letterhead.

MAIL COUPON NOW

BURSTEIN-APPLEBEE CO.
1012 MCGEE, KANSAS CITY 6, MO.
Send me FREE Color Code and Ohms Law Calculator along with latest catalog.

I am _____
STATE CONNECTION IN INDUSTRY

NAME _____
ADDRESS _____
TOWN _____ STATE _____

MINIATURE TUBULAR CONDENSERS

Specialists in the manufacture of tiny, paper, tubular, condensers for hearing aids, portable radios, etc. Moistureproof, High I.R., accurate capacity, and very small physical dimension. We make them by the millions for the armed forces. Tell us your needs.

GOOD-ALL ELECTRIC MFG. CO.
3rd & Main St., Osallala, Nebraska

BUY AN EXTRA WAR BOND

BROADCAST EQUIPMENT

(Continued from page 775)

In this case the laboratory personnel adjust their precision monitoring equipment to the assigned frequency of the station and receives its signal over the air. The station engineer is then advised verbally by telephone what adjustment to make upon the transmitter oscillator frequency. When the carrier frequency has been adjusted to the exact assigned value, the oscillator of the frequency monitor is then calibrated accordingly, to zero drift. If this method is not practicable—when the transmitting station and laboratory are at some distance from each other—a written report is mailed to the station, noting date, time, and frequency deviation. This reading is checked against the indication in the station log for the same time, and the information collated for corrective adjustments to the frequency monitor.

Aural observation of the difference frequency may be made by plugging a headset into the phone jack. However, the phones should be removed from the circuit when not in use, as they upset the accuracy of the visual indicator.

RADIO PROGRAM MONITOR

As a final check on the quality of the radio signal, the transmitter engineer must actually listen to the signal being broadcast from the antenna, for in the final analysis it is the ear of the listening audience which must be favorably impressed. The radio program monitor in its simplest form is a very small receiver, usually fixed-tuned to the station frequency, which intercepts and demodulates a small portion of the radiated signal. A switching arrangement is ordinarily provided whereby the monitoring loud-speaker may reproduce either the audio input to the modulation equipment or the output of the radio monitor, for purposes of comparison. Thus by means

be varied, and a high-fidelity speaker. The overall frequency response of the system must be substantially flat at least over a range of 30 to 8,000 or 10,000 cycles per second.

A typical push-pull type monitoring rectifier is shown in Fig. 2. The pick-up inductance is loosely coupled to the tank circuit of the final R.F. amplifier or to the antenna, preferably the latter. However,

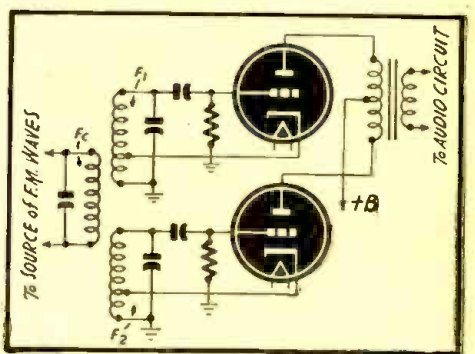
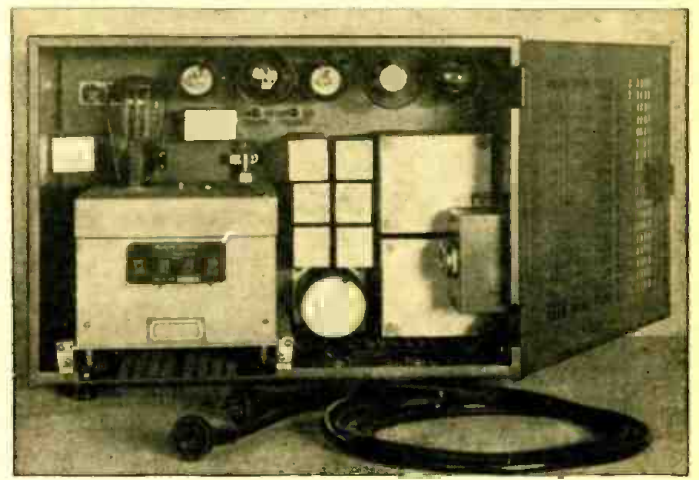

Fig. 2—Push-pull FM monitoring rectifier.

when the rectifier is coupled to the antenna, extreme care must be observed that harmonics produced in the demodulation process are not re-generated into the antenna circuit. It is quite possible for these harmonics to be radiated in such magnitude as to create objectionable interference. For this reason, the even-order harmonic cancellation characteristic of the push-pull circuit makes it very desirable for this application.

Of course, the monitor detector must have a perfectly flat characteristic throughout the entire operating range, so that an exact evaluation of the broadcast program char-

An inside view of the Western Electric frequency monitoring unit which is also shown on page 775 (outside view).



of aural observations and measurements, the transmitter engineer is enabled to determine the relative amounts of distortion in the audio signal before and after it passes through the transmitting equipment. For ordinary constant aural monitoring, the radio monitor is used, for then the engineer can determine instantaneously if trouble develops anywhere in the equipment, including the antenna. The monitoring loud-speaker is preferably located in a room having some proper acoustical treatment, so that a fairly accurate judgment of sound quality may be made. The equipment required consists of a linear detector, a high quality audio amplifier whose output may

acteristics may be made. This calls for the selection of a suitable tube and careful circuit design. It is usually necessary to employ a tube having a high peak inverse voltage in order to withstand surges due to static discharges into the radiator. The design shown has an auxiliary output circuit which may be used to feed a remote antenna meter, or carrier-on indicator light or timer.

MODULATION MONITOR

The FCC requires that every standard broadcast station have an approved type modulation monitor in use at the transmitter, which shall indicate the percentage of

modulation of the transmitter, and shall also provide a means of instantaneously warning when the degree of modulation exceeds any predetermined value. A simplified schematic diagram which illustrates the theory of operation of an approved commercial type of modulation monitor is

ceeds a given value. The flasher is operated by relay tube 885, which in turn is excited by the audio output of the first detector. A relay across the flasher will also operate an alarm if desired.

Next month we shall begin a discussion of broadcast radiating systems.

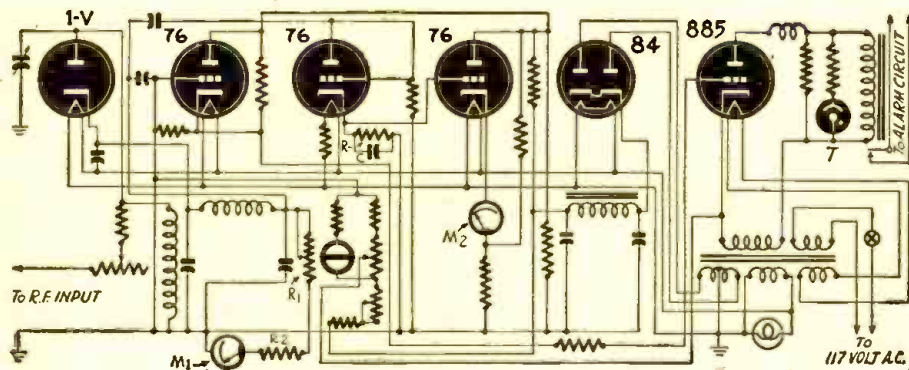
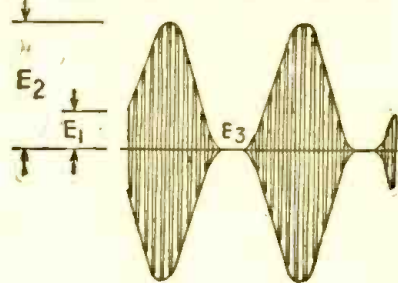

Fig. 8—Simplified schematic of a standard commercial type broadcast modulation monitor.

shown in Fig. 8. A portion of the radiated signal is impressed across the 1-V diode, and is thus rectified. The resulting pulsating D.C. flows through the diode load R_1 and R_2 , and through the carrier meter M_1 , which indicates the average value of D.C. The voltage across the diode load is imparted to two other indicating devices. One of them is voltmeter M_2 , which reads both in decibels and percentage modulation. The audio component appearing across the diode load is detected by the second type 76 tube. The load for this tube is an RC circuit, whose time constant is such that it communicates to the grid of the vacuum-tube voltmeter circuit a signal which causes the meter to indicate the audio peaks on the R.F. carrier. The other indicating device is a flashing neon tube T, which lights whenever the modulation percentage ex-

CORRECTION

Part of Fig. 1 was omitted in the July installment of this series. This missing portion, which was to have been labelled Fig. 1 (D) is printed below. It shows a



carrier wave when more than 100% modulation is applied to it.

A "WOUNDED" FILM RECORDER

Before winning a mythical Purple Heart for wounds caused by Jap shrapnel the film recorder recently returned to the Marine Corps headquarters in Washington, helped tell the vivid story of the Iwo Jima invasion over the American radio networks and in the newsreels.

Another spectacular transcription made on this machine caught the two-way conversation between a disabled tank in a shell hole and another Marine tank attempting to direct a retriever tank to its rescue. The conversation was recorded as picked up on a signal jeep radio aboard an LSM heading on to the beach on D-Day. Used by MGM, it was the first time recordings of actual battle action have ever been used in any newsreels.

Although the direct hits wrecked the machine the two Marine correspondents were fortunately uninjured.

The instrument is the well-known Record-

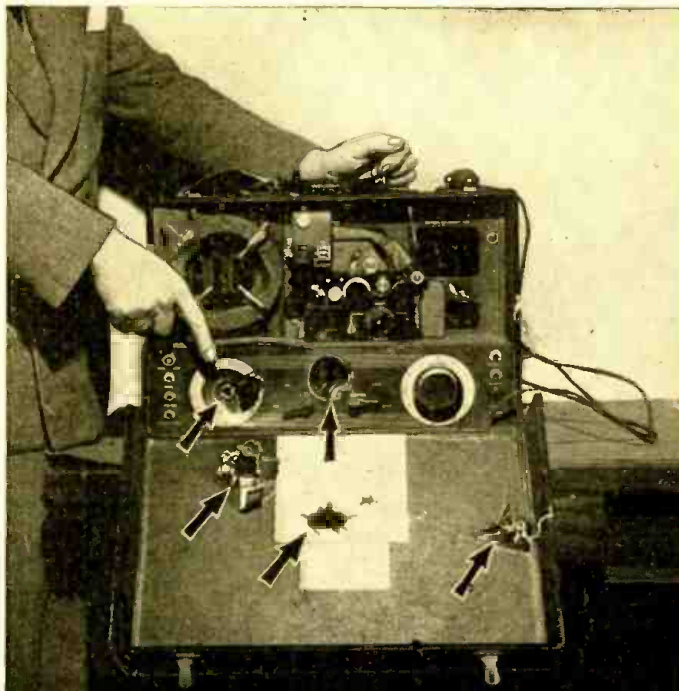

Courtesy, Frederick Hart & Co., Inc.

graph, which was used by George Hicks in the invasion of France. A portrayal of that event appeared on the cover of our last October's issue, which carried an article on the recorder.

LEO'S SPECIAL!

Immediate Delivery

Money Back Guarantee on this all-purpose

Model WRL 300 ONLY \$18.75 Less Leads

Multitester

Handles AC and DC Voltmeter, DC Milliammeter, High and Low range Ohmmeter. Size 5 1/2 x 8 x 3 1/4. 3" meter with sturdy D'Aronson movement. Write for priority information.

See Leo for WRL Radio Kits priority required



Phono Amplifier Kits Complete with tubes, instructions No. 1059... **\$9.50**



Code Oscillator Kits Complete with tube. Size 3" x 6". No. 66-200 **\$4.95**

OUTPUT TRANSFORMERS

15 watt P.P. 6L6 output. To 4 ohm V.C. or 500 ohm line. Fully shielded. No. 9-649. **\$1.65**

Reserve Your Post-War. **HALLICRAFTERS** Now! For preferred delivery place your order now. Write Leo for details. See Terms Liberal Refund.

HALLICRAFTERS Available for immediate delivery in prototype. Write for details.

DUAL FIL. TRANSF. Fully Shielded

110 V. Tapped Primary. Secondary, 5 volt @ 3 amp. and 6.3 V.C.T. @ 4 amp. No. 9-551... **\$2.25**

EXCLUSIVE AT LEO'S!

44 Page Parts Flyer... FREE

Packed with hard-to-get items. Immediate delivery to radio repairmen. Usual priorities. Experimenters write Leo, W9GFQ, on how to get radio repair parts.

- Tube and Circuit Reference Book 10c
- Handy Tube-Base Calculator 25c
- Giant Radio Reference Map, Size 3 1/2 x 4 1/2 ft 15c

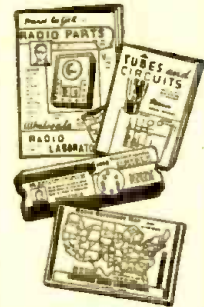

MAIL TODAY

Wholesale Radio Laboratories RC-9 744 West Broadway Council Bluffs, Iowa

- Please rush Multitester No. 300, \$18.75 is enclosed, or Enclosed is \$____, Balance C.O.D.
- Here's 10c, Send "Tubes and Circuits" Book.
- I want a Tube-Base calculator. 25c enclosed.
- Ship me your radio map. 15c enclosed.
- Send me your free flyer of hard-to-get radio parts.

Name _____

Address _____

Town _____ State _____

I am an amateur; experimenter; service man.

QUICK SERVICE

Your order will receive my own personal attention. You'll get "same day" delivery service from the heart of the nation . . . on anything in radio.

Sincerely,
Leo & Ferguson
W9GFQ



Wholesale RADIO LABORATORIES

**NOW—A REALLY HIGH-POWERED—
Radio Engineering
Library**

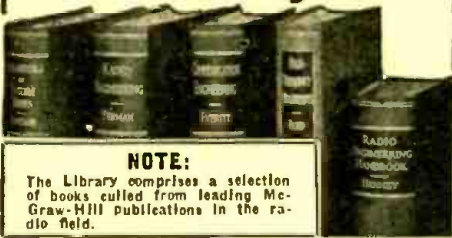

NOTE:

The Library comprises a selection of books culled from leading McGraw-Hill publications in the radio field.

- especially selected by radio specialists of McGraw-Hill publications
- to give most complete, dependable coverage of facts needed by all whose fields are grounded on radio fundamentals
- available at a special price and terms

THESE books cover circuit phenomena, tube theory, networks, measurements, and other subjects—give specialized treatments of all fields of practical design and application. They are books of recognized position in the literature—books you will refer to and be referred to often. If you are a practical designer, researcher or engineer in any field based on radio, you want these books for the help they give in hundreds of problems throughout the whole field of radio engineering.

6 VOLUMES, 3319 PAGES, 2289 ILLUSTRATIONS

1. Eastman's FUNDAMENTALS OF VACUUM TUBES
2. Terman's RADIO ENGINEERING
3. Everitt's COMMUNICATION ENGINEERING
4. Hunda's HIGH FREQUENCY MEASUREMENTS
5. Henney's RADIO ENGINEERING HANDBOOK

10 days' examination. Easy terms. Special price under this offer less than books bought separately. Add these standard works to your library now; pay small monthly installments, while you use the books.

10 DAYS' FREE EXAMINATION—SEND COUPON

McGraw-Hill Book Co., 330 W. 42nd St. New York 18

Send me Radio Engineering Library, 6 vols., for 10 days' examination on approval. In 10 days I will send \$3.00, plus few cents postage, and \$3.00 monthly till \$24.00 is paid, or return books postpaid. (We pay postage on orders accompanied by remittance of first installment.)

Name

Address

City and State

Company

Position RC 9-45

**RADIO
MANUFACTURERS**

We have a daily capacity of 125,000 paper tubular condensers. We manufacture all standard sizes as well as dozens of special sizes. Send us your print—we will gladly quote. Two new waterproof types are available for early production.

GOOD-ALL ELECTRIC MFG. CO.

3rd & Main St., Osallala, Nebraska

**Do you need
BINDING POSTS?**



The XL PUSH POST with its Spring Action assures Constant Contact and quick connection.

Manufactured in All Aluminum Type M at 12c each.

Aluminum Body, Bakelite Top Type B1 at 15c each.

Types CP or NP, ALL BRASS—STAINLESS STEEL, SPRING & PIN, PROVEN BY 240 HR. SALT SPRAY TEST as NON-CORROSIVE at 25c each.

Manufacturers and Dealers Liberal Discounts

X. L. RADIO LABORATORIES

420 West Chicago Ave., Chicago 10, Ill.

Mobile communications, said Domestic Commerce last month, has a postwar market limited only by the 84,684 locomotives, 632,508 trucks for hire and 47,300 taxicabs now in service.

Radio In Water Canteen

"THE only polyglot Musical Canteen in the Southwest Pacific" is what Private First-Class Robert Weinberg of Flushing, New York, calls the radio he has promoted from an assortment of odds and ends that would make the average junk-box radio look like something from the production line by comparison.

Pfc. Weinberg's musical establishment is a diminutive radio built inside a damaged water canteen he salvaged from the beach at Lingayen when he landed with the first assault waves of General Walter Krueger's Sixth Army on Luzon's D-Day, January 9.

The midget receiver picks up stations as far as San Francisco and New Delhi, India, as clearly as though they were transmitting from the next coconut tree.

plane. It hooks to a tiny cogwheel bought in a Philippine clock shop. This drives a worm-gear borrowed from a fire-gutted portable typewriter.

Pfc. Weinberg built the set at odd moments, half the time during blackouts. It took two months. Back in the States he was a radio technician for the R.E.B. Radio Corporation, Flushing, Long Island. He operated his own amateur radio station—W2MCR.

Describing his canteen radio, he says: "It's a regenerative grid-leak detector with two stages audio amplification. The circuit was designed to use what parts I could get rather than what is usually used."

The tubes are tiny 1R5's. To reduce battery drain, since the only source of power is discarded Army dry-cells, an output tube



The paternity of the canteen radio reads like the history of Pfc. Weinberg's outfit, the 293rd Joint Assault Signal Company, attached to the Sixth Army. Battered 1910 model Western Electric headphones used with the set were picked up by boys of the crack Signal Assault Company when they hit the Normandy beach in France on D-Day. Homespun coils are wound around discarded Atabrine tubes from a jungle first-aid kit. Thumbnail condensers were salvaged from Jap radio equipment in the Philippines.

The canteen's top, neck and cork, was cut from the lower half and hinged to it. The top thrown back, reveals the radio panel. It is part of the dashboard of a Japanese truck destroyed in the fighting here. Nip writing on it still confuses Pfc. Weinberg.

Scraps of German signal wire, hinges from a Luzon hardware store, Japanese screws and American nuts all rub shoulders in the Musical Canteen. But the music that comes out is American jive.

With a radio ham's ingenuity, Pfc. Weinberg solved the problem of tuning. For a dial he uses a dime-size bit of plastic glass from a wrecked artillery observation

was replaced by a class-A voltage amplifier.

The set works on any voltage above 45. Its wave length depends on the supply of Atabrine tubes and the time available to wind coils. The set can tune in from ten to 250 meters. Reception from Station KEGR, San Francisco, is exceptionally good.

Most of the wiring used is scrap Signal Corps hookup wire, assault wire and bell-wire (number 18). The antenna runs the length of an army cot, but the set will operate without it. The radio's dimensions are approximately 5" x 5" x 2 1/2".

Marines in Pacific areas are to receive 3,000 radio receivers to supplement those already in their possession, stated Lt. George F. Putnam, USMCR Special Services officer and ex-NBC news reporter.

"Because of the Marines' mobility" says Lt. Putnam, "supplies of 'nonessentials' such as radios has been difficult. But they have managed to listen through PA systems, group radios and improvised sets that range from rebuilt equipment to wired mess kits."

New Direct-Coupled FM - AM AMPLIFIER MANUAL

By **A. C. SHANEY**

Chief Engineer, Amplifier Co. of America

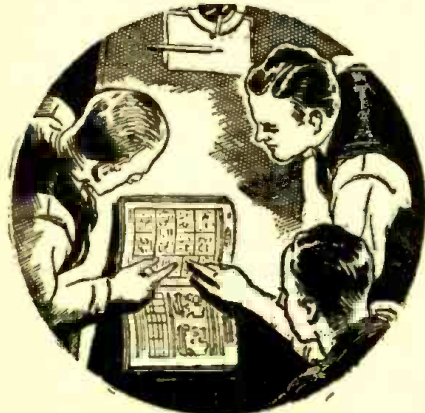

**For the Layman, Serviceman
Recordist and Engineer**

Regardless of whether you are interested in the finest type of phonograph reproduction, high fidelity recordings, sound-on-film applications, FM or AM programs, you will find invaluable information in this practical handbook. Written by the leading exponent of direct-coupled amplifiers who has spent more than 10 years improving and perfecting the famous Loftin-White circuit.

Explains the theory and practical application of:

- Variable Speed Non-Overloading Push-Pull Expansion
- Non-Frequency Discriminating Seratch Suppression
- Push-Pull Balanced Direct-Coupled Amplification
- Push-Pull High-Frequency Equalization
- Push-Pull Low-Frequency Equalization
- Push-Pull Volume Compression
- Automatic Volume Limitation
- Automatic Volume Control
- Calibrated V. U. Indicator
- Audio Spectrum Control
- Remote Control

If you are interested in the latest audio developments, you can't afford to be without this complete compilation of authentic articles on Direct-Coupled Amplifiers. 32 pages 8 1/2" x 11". Over 100 diagrams and illustrations.

Priced to Cover Cost of **25c**
Printing and Mailing

Send U. S. Stamps or Coin

AMPLIFIER CO. OF AMERICA

896 BROADWAY

NEW YORK, N. Y.

**YOUR NEW FREE CATALOG
IS READY FOR YOU!**

Radionic's Catalog No. 26 lists hard-to-get radio parts. Helps you fill your radio and electronic needs. All parts are available for immediate shipment. All are highest quality. All are exceptional values.

SEND TODAY FOR YOUR
FREE COPY TO Dept. 9E

**RADIONIC EQUIPMENT CO.,
"CHANCELLOR" PRODUCTS
170 NASSAU STREET, NEW YORK 7, N. Y.**

LEARN RADIO EASIER... FASTER "THE MYSTERY OF RADIO"

NOW
READY



WELL
ILLUSTRATED

simplifies training procedure, by outlining T-R-F and superheterodyne principles.

EXPLAINS the network of circuits (One at a time) of an AC-DC five tube superheterodyne system.

ORDER this practical training aid without risk. If not fully satisfied, return within 3 days for refund.

Only \$1 Postpaid.

Send money order, bill or check.

SCIENTIFIC RADIO SERVICE SYSTEM
St. Louis, Mo. Dept. C Box 1285

1	2	3	4
5	6	7	8
9	10	11	12
13	14	15	16

ELECTRONIC Puzzle Square

By

LT. C. K. JOHNSON

This puzzle will refresh your memory in the use of powers of ten. Work problem Number One. Convert its answer to a number between one and ten times, the proper power of ten.

Work the other problems in the same manner. The power of ten for the first problem goes into square No. 1. The power of ten for the second problem goes into square No. 2, etc.

Add the powers of ten, or exponents, in rows, columns and diagonals and they will total the same figure. This total is also your power of ten for square No. 10.

For example: Problem: 21×10^2 Answer: 2100 Convert to 2.1×10^3 . The power of ten in this case is 3. Therefore 3 would go into the square. Now work out the following problems.

- 3.48×10^{-8}
- If you were operating a 6000 kc. crystal on the 17th harmonic what would your output frequency in kcs be?
 $590 \times 10^9 \times 790 \times 10^2$
- $55 \times 10^3 \times 53 \times 10^0$
- What does the meter read in amperes?
- A kilocycle is how many cycles?
6. I
- What is the total capacitance in farads between A and B?

- 8.39 amps equal how many microamps?
- What do you multiply milliamperes by to obtain amperes?
- What should be the speed in RPM, of a 4 pole alternator with an output of 60 cycles?
 $78 \times 10 \times 4 \times 10^4$
- $\sqrt{10^{-8}}$
- $E=10^2$ volts, $I=10^{-6}$ amps.,
 $R=$ ohms?
- Total capacitance in farads between A and B is?
 $A \text{---} \text{---} \text{---} \text{---} B$
 $10 \mu\text{fd} \quad 1 \mu\text{fd} \quad .1 \mu\text{fd}$
- $E=6$ volts, $P=.12$ watts, $I=$ amps?
- — — (CODE)

See page 813 for answers

Postwar research by General Electric will require new laboratory facilities to the extent of \$8,000,000. These will take the form of a new building, to be built on a 219-acre estate near Schenectady.

A feature of the new building, to be built in the shape of a giant T, will be movable walls and partitions that can be set at 18-inch intervals so that rooms can quickly be made large or small as desired. Benches and all furnishings will be standardized so they can be easily shifted as the need arises.

The site of the new building is on a high elevation, thus permitting experiments with radar, high-frequency jet engines and other devices.

Immediate Delivery from

LAKE

**RADIO
cabinets &
parts**



Portable Phonograph case, of sturdy durable plywood, in handsome brown leatherette finish. Has blank motor board. As illustrated above. **\$6.95** specially price at

Also blank table cabinets of walnut veneer in the following sizes, with speaker opening on left front side: (Note: 7 1/2" has center speaker grill.)

#1	8 1/2"	L x 5 1/2"	H x 4"	D \$1.95
#2	10 1/2"	L x 6 1/2"	H x 5"	D \$2.75
#3	13 1/2"	L x 7 1/2"	H x 6 1/2"	D \$3.25
#4	15 1/2"	L x 8 1/2"	H x 7 1/2"	D \$2.50
#5	17 1/2"	L x 9"	H x 8 1/2"	D \$4.50
#6	21"	L x 9 1/2"	H x 10 1/2"	D \$5.50

*Speaker Opening in center of front side. Cabinets available in Ivory color and Swedish Modern. Write for prices.

POWER TRANSFORMERS

- 4, 5, or 6 Tube—6.3V at 2 amp. **\$2.45**
- 50 Mil Power Transformer
- 7, 8, or 9 Tube—6.3V at 3 amp. **\$2.65**
- 70 Mil Power Transformer

All types of radio cabinets and parts are available at Lake's lower prices. A large stock is listed in our catalog.

SERVICEMEN-RETAILERS
Join our customer list today.
Write for our free new illustrated catalog.

Dept. C

LAKE RADIO SALES CO.

615 W. Randolph Street, Chicago 6, Ill.

Ted McElroy

World's Largest Manufacturer of
Wireless Telegraphic Apparatus

COMPLETE CENTRAL OFFICE EQUIPMENT

McElroy Manufacturing Corp.

82 Brookline Avenue • Boston, Massachusetts

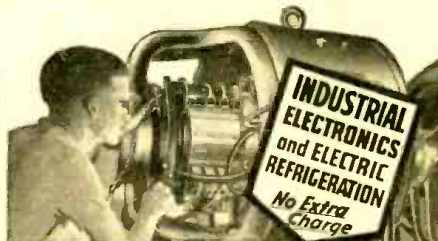

**TRAIN FOR
A GOOD PAYING JOB IN
ELECTRICITY
WITH A REAL PEACE-TIME FUTURE!**

Pay Tuition After Graduation

Practical training on real electrical equipment. "Learn-by-Doing" at Coyne — 12 weeks' shop training. No previous experience or advanced education needed. Prepare for a good job in vital work—protect your future. **EXTRA INDUSTRIAL-ELECTRONICS and ELECTRIC REFRIGERATION TRAINING — NO EXTRA CHARGE!** "Part-Time Employment Plan" and "Job After Graduation Service" offered. Send coupon now for my Big Free Book. We are equipped to train those who qualify under G. I. Bill. We also have facilities for men with physical disabilities whether due to war or other causes.

H. C. LEWIS, Pres., COYNE ELECTRICAL SCHOOL
500 S. Paulina St. Dep. 65-78, Chicago 12, Illinois

MAIL THIS COUPON TODAY

H. C. LEWIS, Pres., Coyne Electrical School
500 S. Paulina St., Dept. 65-78, Chicago 12, Ill.

Send Big Free Book and details. Send G. I. Bulletin Send Physical Disability Details

Name.....

Street.....

City..... State.....

★ BUY AN EXTRA
WAR BOND ★

MATHEMATICS FOR RADIO

Two volumes, prepared for home study. Book I (314 pp.) covers the algebra, arithmetic, and geometry; Book II (329 pp.) covers the advanced algebra, trigonometry, and complex numbers necessary to read technical books and articles on radio.

MAEDEL PUBLISHING HOUSE Room 117
593 East 38 Street, Brooklyn, New York
Send me MATHEMATICS FOR RADIO AND COMMUNICATION as checked below. I enclose payment therefor with the understanding that I may return the book(s) within 5 days in good condition and my money will be refunded.

Name

Address

- Book I at \$3.75 plus 6c postage
- Book II at \$4.00 plus 6c postage
- Books I and II at \$7.75 Postage prepaid

Foreign and Canadian prices 25c per volume higher

ELECTRICIANS! RADIO MEN!

Earn More Money!

Get this new
GIANT SIZE

ELECTRICAL and RADIO TROUBLE SHOOTING MANUAL
GUARANTEED BY COYNE

Yours 10 Days Free

OVER 500
Large Size
Electrical and
Radio
Shop Prints
How to read them

Needed by war workers, maintenance men, beginners, old timers! Nothing else like it. Saves time, helps boost your pay... 4 GREAT BOOKS IN ONE!
1. New Step-by-Step Trouble Shooting Course. 2. 500 Shop Prints. 3. Elec. Radio Dictionary. 4. Spare Time Jobs.

FREE! 1 yr. Technical Counsel by mail from COYNE staff, on trouble-shooting problems.

SEND NO MONEY! See offer below. Satisfaction guaranteed by famous COYNE "Learn-by-Doing" Electrical School. Rush coupon now!

H. C. LEWIS, Pres., Dept. 65-71
COYNE ELECTRICAL SCHOOL
500 S. Paulina St., Chicago 12, Ill.
Send, with all shipping charges paid, your new COYNE Electrical and Radio Trouble Shooting Manual. Within 10 days after getting it I'll either return it or send \$3, then \$3 monthly until total of \$8.90 is paid. (Cash price \$8.00—you save over 10%. Same 10-day free trial and return privilege.)

NAME _____
ADDRESS _____
CITY _____ STATE _____

Whatever YOU WANT In A HEADSET



Scientifically Built
Heavy bar mag. Beta greatly increase their efficiency.

You'll find in a Cannon-Head Guaranteed Headset. Sensitivity, Clarity of tone. Dependable performance. Quality at fair price. Folder R-9 illustrates complete line. Write Headset Headquarters.

C. F. CANNON COMPANY
SPRINGWATER, N. Y.

RADIO ROBOT FLAME TANKS

(Continued from page 766)

such cover as trees, sandbags or natural protection of the terrain.

The tanks themselves are directed by a light-weight hand transmitter, as shown in our illustration. This need not be bigger than an ordinary handie-talkie and houses a transmitter only. Normally, this transmitter is operated by pressing a series of push-buttons. A series from ten to fifteen buttons is sufficient to control the tank in every possible manner.

One button is for starting, another one is for stopping, a third for reverse, another to operate the flame thrower, a corresponding one to stop the flame thrower, etc., etc.

As the flame tanks are always within sight (either direct or through binoculars) not much transmitting power is required and the latter need not operate further than one or two miles at the most. Therefore it can be battery operated. Because it uses microwaves it is also safe and—for reasons mentioned above—completely free from willful interference by the enemy. Many technical refinements and safeguards need not be recited here. In the coming invasion of Japan it would seem to be a foregone conclusion that the fighting conditions which we encountered in Okinawa will not only be repeated, but will increase a thousand-fold.

It is to be hoped that radio controlled flame robot tanks will soon make their appearance as they are certain to eliminate untold casualties during the final campaign.

NEGATIVE FEEDBACK

(Continued from page 777)

In making experimental tests, an output of 5.1 watts was realized under plate and screen supply voltages which previously gave only 3.5 watts.

What this method really does is to provide the equivalent of grid current operation without grid current flowing in the control grid circuit. Its biggest disadvantage is the increase in screen dissipation and its most useful application will be in the field of low-voltage operation that includes portables and deaf aids.

SIMPLE MULTITESTER FOR VOLTS AND OHMS

(Continued from page 778)

meter mounting bolts. The large hole is approximately 1/2 inch from the top of the panel. The two 1/8-inch holes are drilled at the bottom edge of the front panel for mounting the strip to the meter case. Another 1/8-inch hole is drilled at the top of the panel. The masonite panel is 5 1/4 inches long by 3 inches wide by 1/4 inch thick.

The two panels for the sides of the meter case are made from soft wood 5 1/4 inches in length by 3 inches wide. They can be made from cheese boxes sanded and cut to the proper size. The cracks can be filled with plastic wood or crack filler. One coat of brown enamel is sufficient for an attractive finish. The scale markings can be calibrated by using a laboratory precision resistance. In all voltage and resistance measurements, a standard 20,000-ohm-per-volt meter was used for comparison accuracy.

The instrument was put together very rapidly out of scrap equipment, is reasonably accurate and has been giving good service for some time.

HARD-TO-GET PARTS

METERS

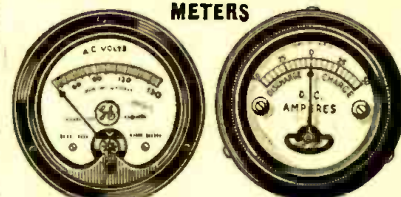

GENERAL ELECTRIC, A.C. Voltmeter, 0 to 150 volts, type A022, 3 1/2" flush mounting. Ship. weight 2 lbs.
ITEM NO. 153
YOUR PRICE **\$9.75**

GENERAL ELECTRIC, A.C. Ammeter, 0 to 150 amperes, type A022, 3 1/2" flush mounting. This is a 5-ampere A.C. meter and may be used as such with no changes. For the 150-ampere range, a current transformer is necessary. Shipping weight 2 lbs.
ITEM NO. 154
YOUR PRICE **\$8.75**

HOYT D.C. Ammeter, 50-25-0-25-50, type 531, 1 1/2" flush mounting. Ship. weight 1 lb.
ITEM NO. 155
YOUR PRICE **\$1.75**

ULTRA MAGNET

LIFTS MORE THAN 20 TIMES ITS OWN WEIGHT

LITTLE GIANT MAGNET

Lifts 5 lbs. easily. Weighs 4 oz. Made of ALNICO new high-magnetic steel. Complete with keeper. World's most powerful magnet ever made. The experimenter and hobbyist will find hundreds of excellent uses for this high quality permanent magnet. Measures 1 1/4" x 1 1/4" Ship. Wt. 3/4 lbs.



ITEM NO. 159
YOUR PRICE **\$1.50**

GENUINE MICROPHONE TRANSMITTERS



Regular telephone transmitters taken from a large telephone supply company's overstock. Work perfectly on 2 dry cells. Can be used on P.A. systems, call systems, intercommunications a e t a, short-line telephone circuits, house-to-house or farm-to-farm 'Phone lines, also to talk through your own radio or as concealed dictaphone pick-up. Useful replacements on battery-operated rural telephone lines.

THESE ARE GENUINE TRANSMITTERS, MADE BY KELLOGG, WESTERN ELECTRIC AND STROMBERG-CARLSON, excellent in appearance and operation. A remarkable value and one seldom offered in these times. Ship. Wt. 1 lb.

ITEM NO. 160
YOUR PRICE **\$1.50**

AMAZING BLACK LIGHT!

Powerful 250 Watt Ultra-Violet Source



The best and most practical source of ultra-violet light for general experimental and entertainment use. Makes all fluorescent substances brilliantly luminescent. No transformers of any kind needed. Fits any standard lamp socket. Brings out beautiful opalescent hues in various types of materials. Swell for amateur parties, plays, etc. To obtain unique lighting effects. Bulb only. Ship. Wt. 1/2 lbs.

ITEM NO. 87
YOUR PRICE **\$2.45**

WESTERN ELECTRIC BREAST MIKE

This is a fine light-weight aircraft carbon microphone. It weighs only 1 lb.

Mike comes with breastplate mounting and has 2-way swivel adjustment so that it can be adjusted to any desired position. There are two woven straps: one goes around neck, the other around chest. Straps can be snapped on and off quickly by an ingenious arrangement.

This excellent mike can be adapted for home broadcasting, private communication systems. By dismantling breastplate, it can be used as desk mike.

Comes complete with 6-foot cord and hard rubber plug. Finished in sherdarized plastic, non-rustable. Shipping weight, 2 lbs.

ITEM NO. 152
YOUR PRICE **\$2.55**

WATTHOUR METER

Completely overhauled and ready for immediate service.

Designed for regular 110-volt, 60 cycle 2-wire A.C. circuit. Simple to install.

2 wires from the line and 2 wires to the load. Sturdily constructed in heavy metal case. 8 1/2" high, 6 1/2" wide, 5" deep. Westinghouse, G. Westinghouse, Bangamo or other available make. Ship. Wt. 14 lbs.

ITEM NO. 33
YOUR PRICE **\$5.95**



HUDSON SPECIALTIES CO.

40 West Broadway, Dept. RC-9-45, New York 7, N.Y.

I have circled below the number of the items I'm ordering. My full remittance of \$..... (include shipping charges) is enclosed (NO C.O.D. ORDERS UNLESS ACCOMPANIED WITH A DEPOSIT.) OR my deposit of \$..... is enclosed (30% required), ship order C.O.D. for balance. NO C.O.D. ORDER FOR LESS THAN \$5.00. (New U. S. stamps, check or money order accepted.) Circle Item No. wanted: 163, 164, 165, 166, 160, 87, 152, 33

Name

Address Please Print Clearly

City State

"Spiderweb" Revived In New Loop



Old-time readers will recognize the "spiderweb coil" principle in a new loop put out by the F. W. Sickles Co. The old spiderwebs were wound on spokes, crisscrossing each other to get the greatest amount of inductance for the least capacity. The new loop is wound with one turn of straight wire, then a second turn crimped into short hairpin-like bends, followed by a third straight turn, and so on. This may be seen plainly in the insert at left. The result, as can be seen from the illustration, is to get the greatest inductance and the least capacity in a given space or with a given length of wire.

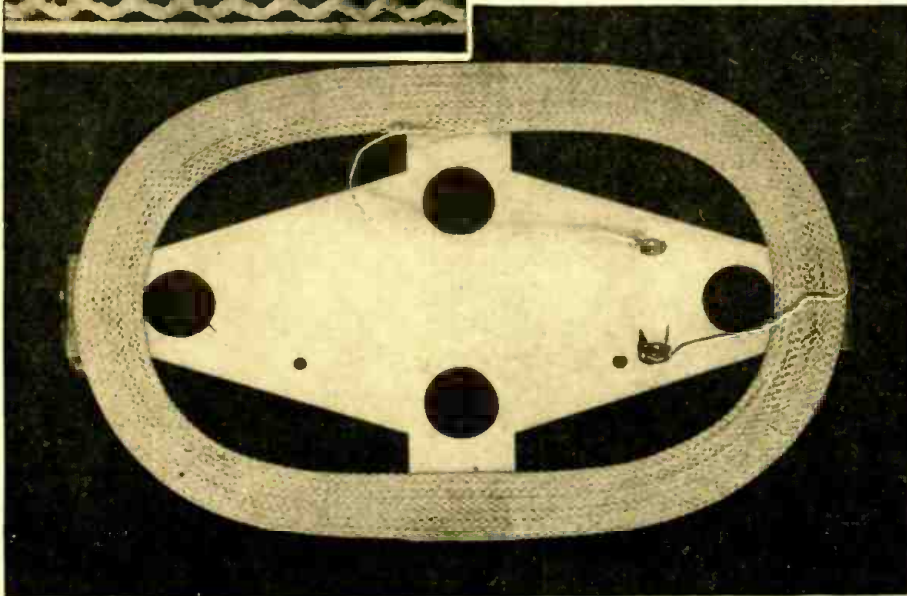

Condenser Connection Pitfalls

The old stunt of connecting condensers in parallel needs very little further rehashing. The total capacitance of a number of parallel condensers is the sum of the individual capacitances. Two 10-mfd. condensers in parallel are equal to a condenser of 20 mfd. Naturally the voltage rating remains the same. If the two condensers have unequal voltage ratings, the lowest is the rating for the combination.

The formula for determining total capacitance is simply $C = C_1 + C_2 + C_3$, etc.

But what happens when you put condensers in series? Ah—then you have some fun. If you put two condensers of equal value in series, the total value is exactly half the value of one unit. The voltage? Why, it doubles its value. "The book" has this to say about it.

"It is sometimes necessary to replace capacitors in circuits where the circuit voltage is higher than the rating of any single capacitor that is available. This requires the connecting of two or more units in series. Capacitors of identical values should be used in making series connections since the applied voltage tends to divide across series capacitors inversely in proportion to the capacitance of the individual units. The voltage on the smaller capacitor may be excessive if there is a great capacitance difference between capacitors connected in series. For most reliable service, it is, therefore, desirable to use units with similar capacitance and voltage ratings in series connections. "The total capacitance of series capacitors is the reciprocal of the sum of the reciprocals of the individual capacitances and may be expressed in the following formula . . ." This in effect tells you that if you had two condensers of .1

mfd. each, both with a working voltage of say, 600, and you put them in series, you would have a condenser of .05 mfd. at 1200 volts.

But what happens when you put a condenser of 40 mfd. 250 volts and one of ten mfd. 250 volts together in series. Then, as the book says, ". . ." If you have the condensers in series and you apply 500 volts across them, strange things may happen. The 10 mfd. condenser acts as a theoretical "resistance" of 266 ohms. The 40 mfd. condenser acts as a theoretical "resistance" of 665 ohms. The voltage then divides itself unevenly with the result that the 10 mfd. 250-volt condenser now has 357.5 volts across it.

THE NEW RADIO RECEIVERS

(Continued from page 761)

when the war caused a shut-down in their production.

The camera types of radios are in for a complete overhauling. They will be much smaller, more compact, and many of them will be housed in plastic cases. They will be much lighter and more efficient than the pre-war types. They will be more sensitive, give better volume and reproduction.

How many additional millions of these small "personal type" radio sets will be manufactured in the first full year after reconversion is anyone's guess. Production certainly will run into many millions because these receivers fill a very important demand. They will in all probability be as popular as the regulation home radio receivers.

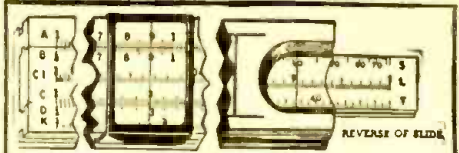

ENGINEERS & DRAFTSMEN'S DAILY NECESSITIES

1. ENGINEERS' SLIDE RULE, Lawrence New "TRIG" 10" Slide Rule with A B C D C I K S L T scale complete with illustrated instructions. Narrow gun-metal finish indicator and leatherette carrying case . . . \$1.50
2. Lawrence 10" white enameled slide rule with A B C D C I and K scales with round magnifying indicator, packed in individual black imitation leather grain pocket case . . . \$1.75
3. R-700 Protractor Ruler with radio and electronic symbols 1 1/4" x 8". Ideal ruler, protractor, circuit diagram builder for radio and electronics, made of transparent material . . . \$1.75
4. Lawrence 32-page complete slide rule instruction book . . . \$1.20
5. Stanley 28-page slide rule instruction book with numerous large illustrations . . . \$1.15
6. Slide Rule CONVERTISOR—6" diameter . . . \$2.00
7. SPEE-DOTTERS for draftsmen, 1 1/4 x 8 centimeters and inch in 1/16ths . . . \$1.00
1 1/8" x 12 1/4", inch in 32ds and 20ths \$1.50
8. THE GOLD SHIELD "2-Glow" NEON Electric Circuit Tester . . . \$1.50
9. MORSE CODE PRACTICE KEY, with 4-page illustrated circular . . . \$3.00
10. "THE INDUCTANCE AUTHORITY" by Edward M. Shiepe, B.S., M.E.E. with 38 full page charts and ten pages of textual discussions by the author, graduate of Massachusetts Institute of Technology and Polytechnic Institute of Brooklyn . . . \$2.50
11. NEW LAWRENCE CODE RULES consisting of two rules and a complete book of instructions with examples, also additional features. Complete set . . . \$1.50
12. STURDY MAGAZINE BINDERS, covered with strong black corrugated fabrikoid. Has two stamped metal ends with 12 spring wire separators. Magazines can be inserted and removed in a jiffy.
Size 1—12 1/4" x 9 1/2", to fit Radio-Craft, Radio News, etc. Each . . . \$2.00
Size 2—10 1/4" x 7" to fit Popular Mechanics, etc. Each . . . \$1.90
Size 3—8 3/4" x 5 3/4" to fit Reader's Digest, etc. Each . . . \$1.80

GOLDSHIELD PRODUCTS

Department RC-9
25 West Broadway, New York 7, New York

In the Rocky Mountain Region

it's

RADIO & TELEVISION SUPPLY CO.
806 EUCLID AVE., PUEBLO, COLO.

"If we don't have it, we'll get it—
or it can't be had! Phone 5729"

TEST EQUIPMENT

—NOW AVAILABLE—

With AA.5 or higher priority.
SUPERIOR PB-100—volt-ohm-milliammeter . . . \$28.40
SUPERIOR CA-10—signal tracer with tube . . . 14.85
RADIO CITY 805 tube and set tester . . . 89.50

25% deposit with order, balance C.O.D.
Write for Bulletin C-1

SCENIC RADIO & ELECTRONICS CO.
53 Park Place • New York City 7

THE BEST VIBRATOR

A small vibrator with a great future:
QUIET! COMPACT! EFFICIENT!

A revolution in Postwar VIBRATOR design. Till materials are more plentiful, we will continue to rebuild old vibrators at \$1.00 each. Include return postage. Send vibrators to

BEST VIBRATOR CO.

BOX 5802-Z CLEVELAND 1, OHIO

PATENTS—TRADE MARKS

Booklet concerning Inventions & Patents Form "Evidence of Conception" with instructions for use and "Schedule of Government and Attorneys Fees"—Free
LANCASTER, ALLWINE & ROMMEL
Registered Patent Attorneys

436 Bowen Bldg. Washington 5, D. C.

**GEOPHYSICAL
PROSPECTING
PRINTS
(TREASURE
FINDERS)**

**50¢ EACH
7 FOR
\$3.—**

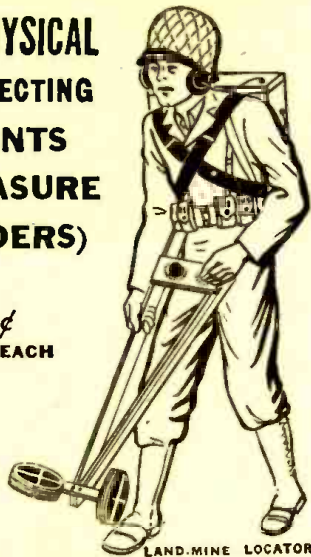

LAND-MINE LOCATOR

With any one of the modern geophysical methods described in the Blue-Print Patterns, radio outfits and instruments can be constructed to locate metal and ore deposits (prospecting); finding lost or buried treasures; metal war relics; sea and land mines and "duds"; mineral deposits; subterranean water veins; oil deposits (under certain circumstances); buried gas and water pipes; tools or other metallic objects sunken in water, etc., etc.

- Folder No. 1. Radiofactor Pilot. Construction and use of 2 tube transmitter and 3 tube receiver. Reflected wave principle. Visual and aural signals.
- Folder No. 2. Harmonic Frequency Locator. Radiates low frequency wave to receiver. Aural signals.
- Folder No. 3. Heat Note Indicator. 2 oscillators. Visual and aural signals.
- Folder No. 4. Radio Balance Surveyor. Balanced loop principle. Modulated transmitter. Visual and aural signals.
- Folder No. 5. Variable Inductance Monitor. Inductance principle. Aural signals.
- Folder No. 6. Hughes Inductance Balance Explorer. Bridge principle. Aural signals.
- Folder No. 7. Radiodvne Prospector. Balanced loop principle. Very large field of penetration. Aural signals.

Each set of blueprints and instructions enclosed in heavy envelope (9 1/2" x 12 1/2"). Blueprints 22" x 34"; eight-page illustrated 8 1/2" x 11" folder of instructions and construction data. **50c**
Add 5c for postage

The complete set of seven folders **\$3.00**
Shipping weight 2 lbs. (add 25c for shipping anywhere in U.S.A.)

Send Stamps, Cash or Money Order to

TECHNIFAX

RC-9-45

1917 S. STATE ST. CHICAGO, ILL.

TECHNIFAX 1917 So. State, Chicago, 16, Ill.

Enclosed herewith \$..... for which mail to address below:

Treasure Finder No. 1, 2, 3, 4, 5, 6, 7. Complete set of seven folders.

NAME

ADDRESS

CITY STATE

RC-9-45

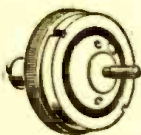

**"WONDER"
ELECTRIC BUTTON**

Most interesting electrical apparatus ever discovered. Make your own Telephone Amplifier. Detectiphone. Transmit your voice or music to distant rooms. Perform hundreds of fascinating experiments. So tiny it can be concealed in dozens of places. Send \$1 now for button and free 5,000 word instruction booklet with 50 illustrated experiments. SPECIAL OFFER 6 buttons and booklets sent postpaid for \$5. Write now to

BUCK MFG. COMPANY North Aurora, Illinois



MAGIC CUTTER

Cuts up to 4" hole in plastics, wood and metal. Wonder tool for amateurs and professionals developed by famous job for own use. Send \$1 to: Tool Division **ROBERTS ASSOCIATES** 510 Madison Ave., New York, 22

Communications

SOME RADIOMEN A MENACE TO LIFE?

Dear Editor:

No good radioman need be afraid of a license, examination for which should be along the lines of electrician's license. How many sets have come to my place with dangerous wires exposed, where the electric wire, rubber covered, the rubber having dried up and fallen off.

If a man should be licensed to have charge of boilers, elevators, electric work, plumbing, then so should radiomen. How many radiomen replace condensers that are falling apart, as long as they will still work? How many replace charred resistors or uninsulated wires?

Not long ago two men were burned to death trapped in their bathroom. Firemen blamed the cord on the radio which had lost its rubber insulation and had shorted. What radioman was a murderer in this case? There are many radio stores today

operated by men out for big dough, regardless of how they fix the radios. They damage speakers, damage transformers, damage tubes and almost everything else in sets. Their only interest is big dough, blood money, robbing the parents of the boys who are dying for such as they.

Referring to Jack Geier's letter, May 1945 issue, the writer only had up to second year high, but considers 20 years study of radio and electronics just as much an education, as any college course. More, as I have worked with the materials, not just theories. Many electricians and plumbers pass exams for a state license in Pa. and have hardly more than grammar school education. An examination would require you to know safety factors, tube circuits, limitations of radios, NOT booklarnin'!

DAVID V. CHAMBERS,
Philadelphia, Penna.

BLOOPERDYNES AND LICENSE PROBLEMS

Dear Editor:

Wilbur T. Morrison seems to forget that things are not what they used to be and that there are still many beginners who like to start off with the one tube "blooperdynes" as he calls them.

I was one of those not more than four years ago and I still like to study those circuits. I agree that the same hook-up may have been used more than once in any year but there is always someone who wants a circuit of that type.

Reading the discussions as to whether servicemen should be licensed or not; I

tend to agree that they should be for their own protection. I think that the examinations should be graded as A, B, and C for A, B, or C servicemen.

I own a considerable amount of equipment and am called in preference to many of the larger shops in my district. I think that if I had a license it would show my customers that I know what I am doing. New customers are in doubt as to whether I know my work or not. A license would remove that doubt.

HAROLD CHAPMAN
Toronto, Ontario

A BETTER HIGH-FIDELITY CIRCUIT

Dear Editor:

I refer you to Mr. Cartwright's letter on page 580 of the June issue of *Radio-Craft* concerning a "hi-fi" amplifier.

I would like to point out to Mr. Cartwright, and any one else who is interested that the amplifier which is printed on that page as Figure 4 is by no means "hi-fi."

that power, the per cent of distortion would be 63.87%!

I'll have to admit that the circuit at least works and that phase distortion is comparatively low.

I am submitting herewith, a diagram of a really hi-fi rig. The diagram is self-explanatory except for points A and B. If a

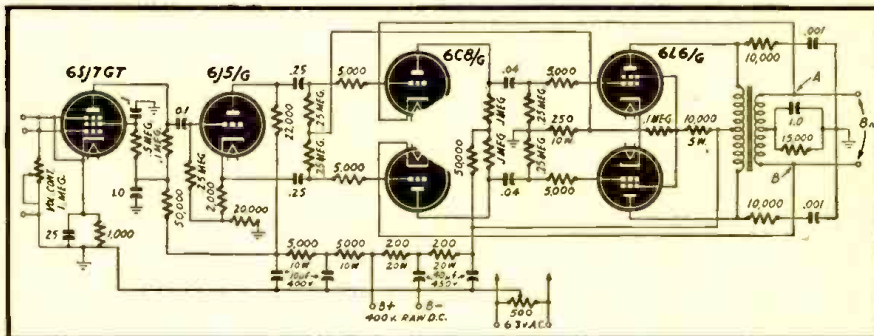

Some engineer friends of mine at radio station WEEI in Boston have done some experimenting with that type of power amplifier and have found that the distortion percentage is so high that it makes the circuit completely impractical. They constructed such an amplifier using 6L6's and found that at 2.5 watts the distortion was as high as 12%. (The amplifier was supposed to deliver 15 watts undistorted power output. At

squeal results when the amplifier is put into operation, reverse the two points. The output is completely flat (plus or minus 0 db), across a range of 25-20,000 cycles. Power output is between 10 and 15 watts. Any type of standard rectifier circuit may be used.

G. BRADFORD TIFFANY
Chief Engineer, WECCB
Boston, Massachusetts

SPACE-CHARGE RADIOS

Dear Editor:

Permit me to give you a suggested correction on circuit No. 4 of the article "Space-Charge Set" in the Radio Electronic Circuits in the May, 1945, issue of *Radio-Craft*.

The suggested corrections are to lower the plate voltage from 45 volts down to about 10 or 12 volts. I found this out the hard way many years ago, in using 49 tubes. By using 45 volts on the space-charge grid, you will ruin the tube through internal shorts and reduce the effective emission, since the grid will usually run red hot. Tubes that have an external suppressor grid lead not internally connected to the filament or cathode can be worked with some success as space-charge tubes, if the maximum voltage on the control grid is approximately 2/3 of the normal bias voltage. I have used 6C6 and 6D6 tubes in this manner. I have tried to work the 49 tubes as low-plate-voltage space-charged R.F. amplifiers, but have met with no success.

JAMES CHARLES SOUKUP RT2/C,
Somewhere in Europe.

WE STAND CORRECTED

Dear Editor:

On page 351 of your March issue ("Seven Tube Super"), I doubt if you can stabilize an oscillator by returning the oscillator coil to AVC along with the tuning condenser. It would be necessary to use a special tuner with the stators insulated. These two points should be grounded. The connection for AVC is an excellent one.

I suggest the use of a cut section tuner for this set, thereby obtaining tracking over the band inasmuch as only BC is used.

I have read and enjoyed your magazine for many years and make only two suggestions.

1. Print a list of tube substitutions and their connections.
2. Print as many service instruments as you can, particularly those that use parts that are obtainable without difficulty.

S/SGT. LEE A. DUNLAP
Wilmington, Delaware

(The tuning condenser should have gone to ground. This was a draftsman's error. As it is a ganged condenser, and as the first section did go to ground, it would have been fairly impossible to do otherwise than so return it. Articles on the two subjects mentioned have been run in recent issues and we are still featuring them. The series, "Tube Substitutions" is especially useful in connection with the many substitution lists now available.—*Editor*)

AFRAID OF COMPETITION

Dear Editor:

I would like to touch on a subject that has come up for a goodly share of discussion in recent issues. This is the licensing of servicemen. The only conclusion that can be drawn from most of these communications is that *the writers are afraid of competition*. If the purpose that the license is supposed to serve were more clearly defined by its exponents, possibly it would meet with greater acceptance. A man could be an excellent technician but had absolutely no business ethics and therefore give the trade a bad name. On the other hand an excellent practical mechanic with a wealth of experience might be prevented from making a living because he could not pass an examination that would be made up of questions he might never encounter in the course of a year's work.

The ideal organization for servicemen



HELP WANTED TRANSFORMER & SMALL ELECTRIC MOTOR MEN ENGINEERS DESIGNERS DRAFTSMEN & PATENT DRAFTSMEN TECHNICIANS

For war time and post-war design and development of intricate, specialized, hermetically sealed transformers, and special purpose fractional h.p. motors.

Write, giving details about age, experience, past salaries to

SPERRY

GYROSCOPE COMPANY, INC.
RESEARCH LABORATORIES
STEWART AVE. AND CLINTON RD.
GARDEN CITY, NEW YORK

ELECTRICAL and RADIO ENGINEERS RADIO TECHNICIANS

For Design, Development and Production Work. Post-war Opportunity. Also Openings for Mechanical Draftsmen, Junior and Senior Designers.

ALLEN D. CARDWELL MFG. CORP.
81 Prospect St. Brooklyn

would be one similar to the *Institute of Radio Engineers*. Membership in an organization of this type should be voluntary and each community should have its own chapter supported locally and governed locally according to a national constitution. The organization if properly set up, would be the best instrument for good in the service field, just as the I.R.E. has been in the field of engineering. An organization of this type headed by a competent executive would have no difficulty in obtaining members and in a very short length of time, would be able to right the troubles existing in the service field simply because a properly educated public opinion would be overwhelmingly against any technician not a member in good standing with the association.

W. H. ARTKIN, JR.
Toronto, Ontario

Answers to Electronic Puzzle

(page 809)

-6	5	4	-1
3	0	-7	6
-3	2	7	-4
8	-5	-2	1

ENGINEERS WANTED

Here's an opportunity to join one of America's largest manufacturers of electronic and communications equipment.

Radio
•Electrical
Electronic
Industrial
(Job evaluation)
•Mechanical
•Factory Planning
Materials Handling
Manufacturing Planning

Work in connection with the manufacture of a wide variety of new and advanced types of communications equipment and special electronic products.

Write giving full qualifications,
or apply to:

R. L. D., EMPLOYMENT DEPT.

Western Electric Co.

100 CENTRAL AV. KEARNY, N. J.

• Also: C. A. L.

Locust St. Haverhill, Mass.

Applicants must comply with WMC regulations

RADIO STATION TECHNICIANS

MEN AND WOMEN

for Point-to-Point International
Radio-Telegraph Stations in the
United States.

Applicants must possess FCC
radio-telegraph commercial li-
cense, and ability to copy Inter-
national Morse code at about
20 wpm.

WMC rules observed.

Apply weekdays except Satur-
days between 10 am and 3 pm

or write

PERSONNEL DEPARTMENT

RCA COMMUNICATIONS, Inc.
64 BROAD STREET
NEW YORK 4, N. Y.



Civilian RADIO JOBS Wanted

FREE WANT-AD SERVICE

CIVILIAN RADIO JOBS WANTED

By Former Soldiers, Sailors, Marines

Radio-Craft offers its help-wanted columns free for the use of honorably discharged men in the armed services. State the type of position you seek, preferred locality, your experience, education, and other details. Confine ad to 50 words, or less. Supply name and address. Army veterans send section number or photostat of discharge paper. Navy men send photostat of discharge paper. Address RADIO-CRAFT, Classified Ad, Dept. 25, West Broadway, New York 7, N. Y. Your ad will contain a box number and replies will be forwarded to you.

AVAILABLE

RESEARCH ASSISTANT, thoroughly experienced market distribution readership opinion; radio, industrial surveys; I.B.M. statistical questionnaire techniques; creative analytical supervisory abilities. Box 9V-2, % RADIO-CRAFT, 25 West Broadway, New York, N. Y.

RADIO-TECHNICIAN desires position as tester or trouble shooter; prefer Lab. experimental work. Box 9V-1, % RADIO-CRAFT, 25 West Broadway, New York, N. Y.

EX-MARINE. Attending R.C.A. Inst.; would like

position as radio tech. for some concern. Marvin Barben, 1930 Gr. Concourse, New York 57, N. Y.

RADIO or salesman, 27; desires position with postwar future; salesman in wholesale women's apparel before war; served as radio op. and mech. gun. orator. Nathan Klef, 945 E. 181st Street, Bronx 60, N. Y.

RADIO OPERATOR, 27, single; 5 yrs. Army exp. (code); also willing to learn any other branch of radio with post-war future. John Wamser, 25-86 44th Street, Long Island City, N. Y.

RADOLEK

Radio-Electronic Service Parts



Large stocks assure the finest and most complete selections of all available items at lowest prevailing prices. Thousands of active buyers depend on us for their entire Radio repair and replacement requirements. Because we understand service problems, every order is expedited for delivery in double quick time. Everything we do is planned for convenience and satisfaction to our customers. You will find it profitable to make Radolek your buying headquarters.

FREE BUYING GUIDES

Because of existing conditions we keep our customers right up to the minute on available merchandise by releasing supplements frequently instead of sending our regular Big Profit Guide once a year. Send the coupon now to get these Free Buying Guide Supplements as they are issued.

FREE!



FAST SERVICE!

RADOLEK CO., Dept. C-106
601 W. Randolph St., Chicago 6, Ill.

Please send FREE Buying Guide Supplements

NAME _____
ADDRESS _____

ORDER FROM RADOLEK

Thordarson Transformer Co. went out of existence as an independent concern last month, becoming the transformer manufacturing division of the Maguire Industries.

A STARTLING SUPERHET

(Continued from page 783)

handy. As a matter of fact, you can vary any and all of the condenser and resistor values by as much as plus or minus 10 percent, though it is better to stay pretty close to the original values if possible to do so. Since many component parts have less than 10 percent tolerance it would be unwise to practice this perpetually.

The I.F. transformer should be for 456 kilocycles, but a 465 or 470 kilocycle intermediate frequency transformer can be used instead and the trimmers screwed down further, to align at 456 kilocycles.

A 40-watt lamp was used as a voltage dropping resistor in the filament circuit. An adjustable resistor of suitable wattage rating can be used in place of the bulb with even better results.

The original speaker used was a three-inch PM, but a four-inch speaker would also work in this circuit, probably with better results. A dynamic speaker can be used here if you want to improve the set. You would have to put the field of the speaker in place of the 20-henry choke. This would also have the advantage that it would reduce by one the number of parts necessary in the circuit. An .005 condenser across the speaker can be added if desired. This would improve the tone slightly by reducing the highs. The electrolytic condensers are all rated at at least 250 volts working.

The cabinet can be made of any suitable material. I used the following dimensions in building the cabinet: Front, sides, bottom and top were cut to form a rectangle measuring 7½ x 5½ x 3½. This is a little large for the size of the chassis and speaker but it gives me better tone. There is no end to the improvements you can make, ranging from the addition of a phonograph or record changer to a cocktail bar with accessories.

Index to advertisers

Aerovox Corp.	802
Allen Manufacturing Co.	794
Allied Radio Corp.	760, 805
Amperite Co.	797
Amplifier Co. of America	809
Art Radio Corp.	815
Audel & Co., Theo.	818
Best Vibrator Co.	811
Buck Manufacturing Co.	812
Buffalo Radio Supply	801
Burgess Battery Co.	789
Burstein-Applebee Co.	806
Cannon Co., C. F.	810
Capitol Radio Eng. Institute	787
Cardwell Mfg. Corp., Allen D.	813
Cinaudagraph Speakers, Inc.	795
Concord Radio Corporation	798
Coyne Electrical School	806, 809, 810
DeForest's Training, Inc.	757
Electronic Winding Co.	785
Galvin Mfg. Co.	752
Gateway Publishing Co.	804
General Cement Mfg. Co.	803
General Electric Co.	795
Goldshield Products Co.	811
Good-All Elec. Mfg. Co.	806, 808
Hallcrafters Co., Inc.	755
Henry Radio Shops	799
Hudson Specialties Co.	810
International Detrola Corp.	Inside Back Cover
Kelnor Mfg. Co.	804
Lake Radio Sales Co.	809
Lancaster Allwine & Rommel	811
McElroy, T. R.	809
McGraw-Hill Book Co.	808
McMurdo Silver Corp.	791
Maedel Publishing House	810
Mallory & Co., Inc. P. R.	817
National Radio Institute	751
National Schools	759
National Union Radio Corp.	Back Cover
Onan & Sons, D. W.	799
Opportunity Adlets	815
Personnel Help Wanted	813

RADIO SCHOOL DIRECTORY

Page 816

American Radio Institute
Candler System
Capitol Radio Engineering Institute
Commercial Radio Institute
Lincoln Engineering School
Melville Radio School
RCA Institute

RCA Communications	813
Radio Kits Co.	815
Radio & Television Supply Co.	811
Radio Electric Service	803
Radio & Technical Division	
Murray Hill Book Co.	780, 781
Radio Wire Television, Inc.	796
Radionic Equipment Co.	809
Radclma	803
Radolek Company	814
Raytheon Mfg. Co.	Inside Front Cover
Rider, John F.	793
Roberts Associates	812
Scenic Radio & Elec. Co.	811
Scientific Radio Service	809
Sprague Products Co.	756, 779
Sprayberry Academy of Radio	753
Superior Instruments Co.	797
Sperry Gyroscope Co.	813
Supreme Instruments Corp.	800
Supreme Publications	801
Sylvania Electric Co.	758
Technifax	812
Triplet Electric Instrument Co.	783
Ungar Electric Tools, Inc.	780
Western Electric Co.	813
Wholesale Radio Laboratories	807
X-L Radio Labs.	808

BOOK REVIEWS

HIGH-FREQUENCY INDUCTION HEATING, by Frank W. Curtis. Published by McGraw-Hill Book Co. Stiff cloth covers, 5½ x 8½ inches, 235 pages. Price \$2.75.

The author's purpose according to the preface, is to offer the user of high-frequency induction-heating equipment basic technical application details that will serve as a ready reference in connection with the heating of metal parts, such as may be required for hardening heat-treating, brazing, soldering, annealing, stress-relieving, forging, upsetting or melting. As such, the approach is strictly practical, only enough theory being given to make the rest of the material intelligible.

After the first two chapters—on principles of induction heating and types of equipment—questions of design and application are taken up in detail. Forty-two pages are devoted to the design of heating coils alone. Chapters on brazing, soldering and joining; and hardening and heat-treating, follow. A full chapter on fixtures for induction heating discusses the mechanical angles of handling pieces of different sizes, shapes and weights, as well as applications, from deep annealing to the flowing of super-thin layers of tinplate.

The book closes with chapters on miscellaneous applications, designing for induction heating, and dielectric heating. Coverage of this last important branch is necessarily sketchy, and no doubt a full book could have been devoted to it alone.

TELEVISION PROGRAMMING AND PRODUCTION, by Richard Hubbell. Published by Murray Hill Books, Inc. Stiff cloth covers. 6 x 9¼ inches. 207 pages. Price \$3.00.

Most supposedly informative books on television blandly proceed to fill up the pages with glowing accounts of what *will* happen, and what *could* be, IF. This is the first book that really tells the reader how it *has been done*, and how what still remains to do, *can* be done. It is written in pure and simple laymanese, for the proposed televisionist or for the lay person interested in television as an art rather than an exact science. The moral and sociological as well as the aesthetic viewpoints are taken from different camera angles. It is at once a treatise on television in all its glowing aspects, and a comparator of the "Ike" (iconoscope) to the motion picture camera.

Simplicity is the keynote, perhaps too much so. An explanation of focal length and the difference in various f stops are gone into at too great length. The various movie tricks as they are applied to the "Ike" are illuminated for the "audience" reader. For the technician and scenario director, the principles underlying television are subtly interspersed into the text. Thus the reader becomes acquainted with such terms and meanings as stereophonic, air-cooled mercury vapor lamps, and acquires a homey familiarity with an understanding of signal-to-noise ratios.—E.A.W.

BEWARE! THE SERVICEMAN!

(Continued from page 774)

radiomen's junk, and it also had a television tube in the center of it. This only showed him a bunch of wavy green lines but no pictures. He tried to make the lines change shape and move around but I guess he saw that he was getting nowhere. I let him see that he didn't make much of an impression on me.

He took out a dirty old black thing with a lot of wires coming out of it, from the set. Then he took out some more parts and stuff. He had to go back to his shop for something or other (I think he said it was a power transformer he needed but that doesn't sound right). This gave me a chance to look over his equipment and see how they work, but the manufacturers purposely make them so complicated and tricky that even an expert electrician couldn't figure them out in less than fifteen minutes.

I did some checking up on prices while he was gone, just so's he wouldn't be able to put anything over on me. I'm passing along the information to the reader for what it's worth. I got it from my janitor who admits that he can repair radios better than most of these so-called radiomen. I also got some good inside dope from one of the kids upstairs who fools around with bells and other stuff, so must know something of what goes on in the radio field. They told me that most radiomen don't know what they're doing and guess almost all the time. He also gave me a list of what parts cost. A condenser only cost three cents except if it's an electrolytic and then it cost about five or six cents. A resistor only costs one cent each. A power transmitter only costs about 30 or 35 cents.

Tubes are cheap also, costing between 23 and 48 cents.

"INSIDE" DOPE ON PARTS

From this price list, you can easily see how much these gyps make on the unknowing customer. I also got some inside dope on what these things are made of. Condensers are nothing more than a roll of ordinary silver paper wrapped up in a cardboard tube with melted wax poured around it. They are graded according to capacity, which in plain language means how much silver paper the tube can hold.

Re-sisters are merely hunks of ordinary carbon put together with two pieces of wire sticking out of them. Some are made with a lot of wire wound around a piece of plaster. These are called wire wound re-sisters. Transmitters and chokes are only big bunches of wire coiled up on pieces of iron cut in the shape of letters like "E" and "L" and "T." Then a lot of tar is poured in and the whole thing is put into a metal box or case. Coils are a bunch of wire wound around a piece of cardboard tube and then covered with wax again. A speaker is just a circle of paper mounted in a metal frame, with a coil of wire wound around the smaller end of it.

Tubes are one thing that always scare the average person into paying a large bill. This bug-a-boo should have been destroyed long ago. Tubes are only little glass bottles with wires inside of them. Some of these wires hold up pieces of metal, while others are apparently just put there for

(Continued on the following page)

OPPORTUNITY AD-LETS

Advertisements in this section cost 20 cents a word for each insertion. Name, address and initials must be included at the above rate. Cash should accompany all classified advertisements unless placed by an accredited advertising agency. No advertisement for less than ten words accepted. Ten percent discount six issues, twenty percent for twelve issues. Objectable or misleading advertisements not accepted. Advertisements for October, 1945, issues must reach us not later than August 28, 1945.

Radio-Craft • 25 W. B'way • New York 7, N. Y.

BUILD RADIO COMPLETE WITH TUBES \$10.95, details. Radio, 9418b Avenue "A", Brooklyn, N. Y.

MULTITESTER FOR SALE, BRAND NEW \$18.75. Order Today. Omaha Radio Products Co., 300 Brandeis Theatre Bldg., Omaha, Nebr.

MAGAZINES (BACK DATED)—FOREIGN, DOMESTIC, arts, books, booklets, subscriptions, pin-ups, etc. Catalog 10c (refund). Clorone's, 863 First Ave., New York 17, N. Y.

CORRESPONDENCE COURSES AND SELF-INSTRUCTION books, slightly used. Sold, Rented, Exchanged. All subjects. Satisfaction guaranteed. Cash paid for used courses. Complete information and 92-page illustrated bargain catalog free. Write—NELSON COMPANY, Dept. 2-39, Chicago 4.

ARE YOU IN NEED OF A RADIO? BUILD YOUR OWN. Our simple instructions require no previous experience. Complete kit with tubes \$10.75. National Radio Distributors, 140 W. 42 St., New York, N. Y.

DANDY SIXTEEN PIECE UNIVERSAL MIDGET tool set: Midget Pliers, Diagonal Cutters, Four Midget End Wrenches, Needle-nose Pliers, screwdriver, Six Punches & Chisel, Round File, Midget Crescent Wrench. \$14.85. Remit Today. Catalogue Free With Order. UNIVERSAL TOOL COMPANY, 1527 Grand, RC, KANSAS CITY 8, MISSOURI.

WANTED VOICE RECORDING MACHINE OR PUBLIC address amplifier that works from 6 volts and 110 volts. Lobard Radio Shop, 1503½ East Blvd., Baton Rouge, La.

SUZPLUS—826'S, 80 WATTS AT 250 MEGACYCLES. List \$19. Sales Price \$3.50 ea., Cathode Ray Tubes, meters, etc. Quest, 395, Great Neck, N. Y.

Radio Tubes!

HARD TO GET FOR THE NEXT SIX MONTHS

Available

FOR IMMEDIATE DELIVERY TUBES & ADAPTORS

To replace

1A5 use adaptor with	1L4 Tube
1H5 " " " "	1S5 " "
1N5 " " " "	1L4 " "
1Q5 " " " "	3Q4 " "
1T5 " " " "	1L4 " "
3Q5 " " " "	3Q4 " "
45 " " " "	3A4 " "
47 " " " "	3A4 " "
6Q7G " " " "	6B8G " "

TUBE WITH ADAPTOR BOXED COMPLETE

Guaranteed to Work

73c

Minimum Shipment 25 Assorted

Write For Prices In Lots of 500 or Over

We Pay Transportation Charges

Send Form L-265 with order

Can supply other tubes without adaptors

Art Radio Corp.

115 LIBERTY ST. NEW YORK, 6 N. Y.

BUILD YOUR OWN MULTI-TESTER

Complete Kit of Parts, Diagrams, Full Instructions, \$14.95

Measures Volts, Ohms and Milli-amperes.

We carry a complete line of Test Equipment Kits and Radio Kits; also a complete stock of parts at low prices.

Write for details and prices.

RADIO KITS COMPANY

Dept. M, 120 Cedar St., New York 6, N. Y.

RADIO SCHOOL DIRECTORY

PREPARE NOW FOR POST-WAR RADIO AND ELECTRONICS

Make a place for yourself in a new world of radio and electronics—a world in which revolutionary electronic developments will require highly specialized technical knowledge. Take a good course now to fit yourself for a good paying job. The training you need can be supplied by one of the schools advertised in this publication.



RADIO

Train with professionals. Complete, intensified courses; Repair & Maintenance, Communications, High-speed telegraphy, Slip transcription, FCC exams, etc.
High School Students accepted for training as Merchant Marine Radio Officers.
 Gov't sponsorship available to veterans.

"A Radio School managed by radio men."
 45 W. 45th St., Dept. RC, New York 19, N.Y.
MELVILLE RADIO INSTITUTE

RCA INSTITUTES, Inc.

Offer thorough training courses in all technical phases of

Radio and Television

DAYS-EVENINGS WEEKLY RATES

VETERANS: RCA Institutes is approved under G. I. Bill of Rights
 For Free Catalog Write Dept. RC.45

RCA INSTITUTES, Inc.
 A Radio Corporation of America Service
 75 VARICK STREET NEW YORK 13, N. Y.

Correspondence Courses In
RADIO and ELECTRICAL ENGINEERING

ELECTRICAL ENGINEERING Get good grasp of wide electrical field. Prepare yourself, at Low Cost, for secure future. Modern, simplified, you can understand quickly.
RADIO ENGINEERING Extra fine course in radio. public address, photo-electric work.
 Trains you to be super-service man, real vacuum tube technician. Servicemen needed badly. Diploma on completion. Tuition \$25, either course. Deferred payment plan.
 Get copies of school catalogs, student magazines, complete details. **SEND NOW!**

FREE

LINCOLN ENGINEERING SCHOOL
 Box 931C-79 Lincoln, Nebr.

COMMERCIAL RADIO INSTITUTE

A radio training center for twenty-four years.

RESIDENT COURSES ONLY

Pre-Induction, Broadcast, Service, Aeronautical, Television and Marine telegraphy classes now forming for October 1. Literature upon request. Veteran training.
Dept. C., 88 West Biddle St., Baltimore 1, Md.

RADIO

RADIO Technician and Radio Communications courses. Register now for new classes starting first MONDAY of each month. Day and Evening Classes.

AMERICAN RADIO INSTITUTE
 101 West 63rd St., New York 23, N. Y.
 APPROVED UNDER GI BILL OF RIGHTS.

SHORT CUT  **CODE SPEED**

Be an Expert

Learn to be a Telegraph or Radio Operator. Thousands of men needed. Intensely interesting work—good pay. Learn at home or wherever you are, quickly, easily, with the famous Candler Code Speed System. Book of particulars Free.
 Candler System Co., Dept. 3-K, Box 928, Denver 1, Colo.

FREE BOOK

RADIO-TELEVISION

ENGINEERING & SERVICING

Now Training Veterans Under "G.I." Bill
 Prepare now for profitable career! ENTER AT ANY TIME. Residence school classes in Radio, Electronics Engineering, Broadcast & Television Engineering and Servicing.
 Write for FREE booklet
 Capitol Radio Engineering Institute
 Dept. RC-9, 1224 16th Street, N. W., Washington 10, D. C.

See Big Ad. Page 187

?? WHY NOT ??

Have you ever asked yourself, "Why can't I have this or that gadget on a radio? Why aren't programs made to fill such and such a need?" If so, you are a charter member of the *Radio-Craft* "Why Not" club. Send us your "Why Not's" on all subjects—serious or screwball, practical or idealistic. We will pay \$1.00 for every one we believe will interest the readers of *Radio-Craft*. You can get the idea from the "Why Not's" printed below. Send in as many as you like. One dollar will be paid for each one printed.

Why not manufacture plug-in type I. F. coils and output transformers as well as antenna and oscillator coils? The leads could terminate in an octal type base with a different pin arrangement for each type. The I. F. transformers could be pretuned and sealed at the factory.—*Ronald D. Brokloff, Johnstown, Penna.*

Why not have the manufacturers put a circular in the radios sold, informing the customer that the serviceman is no magician and that he therefore cannot possibly tell how much the bill is going to be before he diagnoses the set. It can also inform the customer that condensers, resistors, tubes, etc., can break down after they leave the service shop, and that it is not always the fault of the serviceman, or because of poor repairing.—*Mel Neuman, Sydney, Nova Scotia.*

Why not have a pair of photo-electric cells connected to the volume control and the variable condenser through small motors. By just waving your hands you can tune the set and vary the amount of volume.—*Gus Britzman, Houston, Missouri.*

Why not provide pin jacks on the rear of the chassis with connections to all socket terminals? This would enable the serviceman to check the set completely without even taking it out of the cabinet, and would simplify the job of signal tracing.—*Gus Britzman, Houston, Missouri.*

Why not provide an extra socket on the radio chassis for remote speaker or for an earphone for the hard of hearing? A neighbor hears our radio a half mile away on headphones. The lines were strung over a barbed-wire fence.—*Gus Britzman, Houston, Missouri.*

Why not a noise reducing antenna system in which the two side-bands are separately produced? This can be done by modulating two carriers (from the same oscillator) with the same audio signal but 180 degrees out of phase. The higher frequency side-band of one and the lower frequency side-band of the other are selected and transmitted together. At the receiver, the side-bands would be separated and rectified separately. The phase of one signal would be reversed and combined with the other since they are in phase, while static interference on the side-bands would be out of phase and tend to cancel.—*R. D. Lee, Dammerville, New Zealand.*

Why not have two filaments in rectifier tubes in parallel, connected to the same prongs. One can be interrupted by a switch on the side of the tube base. If a filament burns out, the switch is closed and presto—a new tube.—*Pfc. Richard Durbin, India.*
 (This idea was patented by Hugo Gernsback, publisher of *Radio-Craft*, in 1908—*Editor.*)

(Continued from previous page)

their beauty as they don't hold up anything at all. And that's all there is to them. Absolutely all! If you ever get the chance, or if you have a radio at home that you'd like to experiment with, do as I suggest. Take the set apart. Find at least one of each of these parts. Take each one of them apart thoroughly and carefully, noting what goes where so you can put them back again the same way. In the case of the tubes, be careful that you don't damage the glass too much. The paper piece of the speaker is only glued on so it should come off with a slight tug.

Try your best not to break the little wires on the bottom of this, as it's fairly hard to put them back. The condensers can be taken apart with a penknife and a small pair of pliers. Re-sisters might have to be broken apart with a hammer but the cost of these is so small that you can easily afford the fun. After you have satisfied yourself that what I am saying is true, put the set back together again. If you find that it is too much trouble scoop it all up carefully into a large paper bag and take it to your nearest radio store. For a nominal fee (usually about fifty cents to one dollar) he will put it together again for you. Watch him carefully as he does this, for several reasons. You can learn a lot by watching him and listening carefully to his muttering, and you can see that *HE DOESN'T DAMAGE YOUR SET!* In case you have no confidence in him, or if you prefer to put it together by yourself, you can obtain complete instructions by writing for the author's complete instruction manual, en-

closing \$2.00 to cover cost of handling and air-mailing.

EXORBITANT CHARGES

To continue with my exposé: About an hour later the mechanic came back and after fooling around for another hour he fixed the set so that it worked perhaps a little better than before. He gave me a long sales talk about what he did and then presented his bill for \$8.00!! Imagine the nerve of that gyp! After wasting four-and-one-half hours of my time and ripping my entire radio apart, he wanted to charge me \$8.00. I held my temper, though. I told him that I only had \$2.00 on me at the time and paid him that just to get rid of him. He'll never see the other \$6.00 though. I know better than that. If he tries to collect, I'll sue him for fraud.

Now that I have exposed this thieving racket, I'd appreciate any letters from readers who have similar experiences to relate or who can supply additional information on how to beat the radio racketeer at his own game.

In my next article I will give you the inside story of television and tell you how you can repair your own high-voltage-power-supply television receiver and FM set. I am endeavoring to set up a school to teach the layman how to do all these repairs without any instruments at all, but at present we are bound up in red tape and they refuse to give me a license to operate this sort of school. Eventually we will set up this school, in another state if necessary. Then the public will benefit and these crooks will be driven out of business.

Meet the MALLORY "TC" Capacitor!

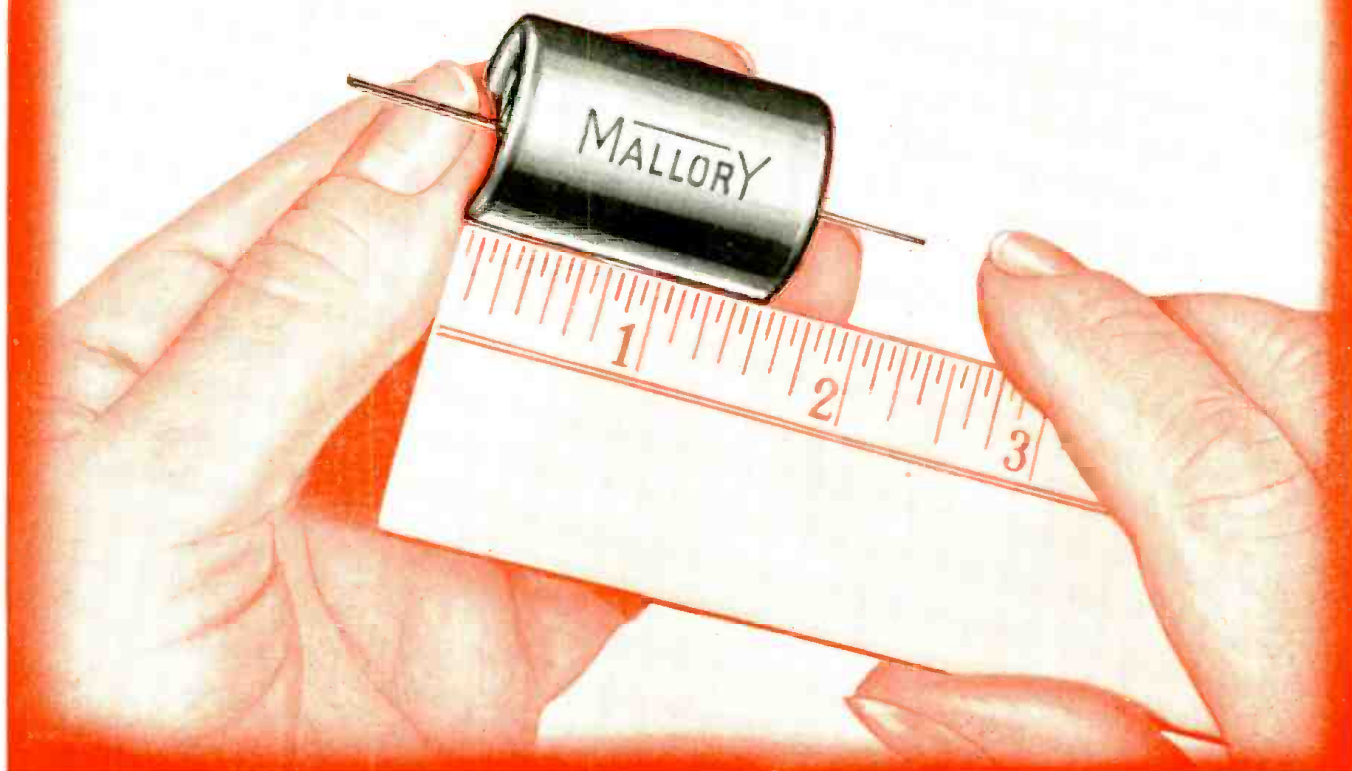

A Tiny Tubular That's New to the Market

YOU'VE heard that good things come in small packages—and this Mallory "TC" proves it!

This capacitor is actually *smaller* than most cardboard types, but is superior in every respect. It's enclosed in aluminum, then hermetically sealed, *then* protected by insulating tubes against possible "shorts."

Just introduced, the "TC" is but one of a series of Mallory tubulars including single capacity, dual common negative and dual separate section units.

Sizes range from $\frac{3}{16}$ " x $1\frac{1}{4}$ " up and there's no sacrifice in ripple current rating or any other characteristic. See your Mallory distributor!

P. R. MALLORY & CO., Inc., INDIANAPOLIS 6, INDIANA



More than ever—
ALWAYS
INSIST ON

P. R. MALLORY & CO. Inc.
MALLORY
APPROVED
PRECISION PRODUCTS

VIBRATORS • VIBRAPACKS* • CONDENSERS
VOLUME CONTROLS • SWITCHES • RESISTORS
FILTERS • RECTIFIERS • POWER SUPPLIES

ALSO MALLORY "TROPICAL"® DRY BATTERIES, ORIGINALLY DEVELOPED BY MALLORY FOR THE U. S. ARMY SIGNAL CORPS, NOT PRESENTLY AVAILABLE FOR CIVILIAN USE.

® Trademarks

**NEW EDITION
NOW READY**

Audels RADIOMANS GUIDE

Includes **TELEVISION
AND ELECTRONICS**

LARGER - MORE COMPLETE - 914 PAGES - 633 ILLUSTRATIONS - WIRING DIAGRAMS - PHOTOS



THE KEY TO PRACTICAL RADIO INFORMATION

It gives you in usable form pointers on radio, including frequency modulation, television, etc. Also valuable inside information for Aviators, Marines, Commercial Operators and Technicians, Servicemen and Students.

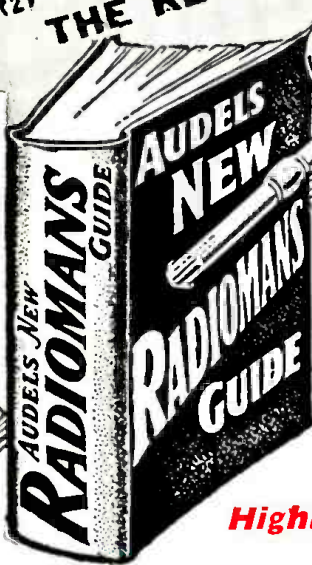

**Q AND A
UNIQUE
QUESTION
and
ANSWER
METHOD**

Highly Endorsed

**1001 RADIO FACTS AND FIGURES
A Complete Library In One Book**

AUDELS RADIOMANS GUIDE gives authentic Principles and Practices in Construction, Operation, Service and Repairs. Covers clearly and concisely radio fundamentals—Ohm's Law—Physics of sound as related to radio science—Measuring instruments—Power supply—Resistors—Inductors—Condensers—Transformers and examples—Broadcasting stations—Radio Telephony—Receivers—Diagrams—Construction—Control Systems—Loudspeakers—Antennas—AutoRadio—Phonograph Pick-ups—Public Address Systems—Aircraft and Marine Radio—Radio Compass—Beacons—Automatic Radio Alarms—Short Wave—Coil Calculations—Testing—Cathode Ray Oscillographs—Static Eliminations—Trouble Pointers—Underwriter's standards—Units and tables. REVIEW QUESTIONS—READY Reference Index.

38 BIG CHAPTERS

Easy to Read - Easy to Grasp - Easy to Apply

A home-study course—especially well organized. The style is so interesting you will read along without effort, hardly realizing that you are actually studying and taking in vital information. Audels Radiomans Guide gives you just the right amount of mathematics required to cope with radio problems successfully. You can solve, with the aid of this extraordinary book, practically every radioproblem that comes up. At your finger tips is a complete index for instant use.



7 DAYS' FREE TRIAL

THEO. AUDEL & CO., Publishers
49 West 23rd Street, New York 10, N. Y.

Mail AUDELS NEW RADIOMANS GUIDE for free examination. If O. K. I will send you \$1 in 7 days; then remit \$1 monthly until \$4 is paid. Otherwise I will return it.

Name _____
Address _____
Occupation _____
Reference _____

4 COMPLETE \$1 PAY ONLY 1 MO.

MAIL THIS COUPON TODAY

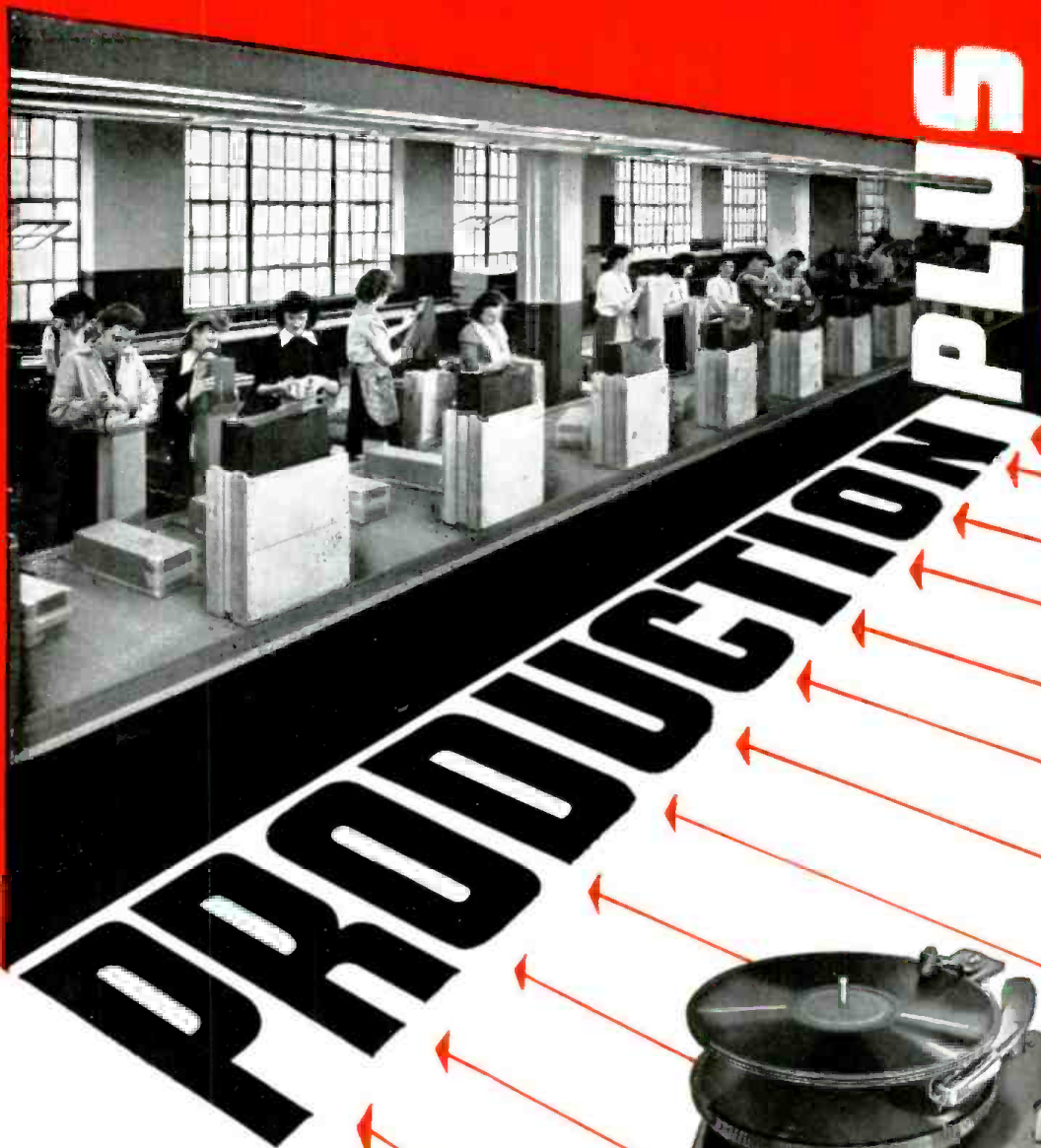

At Detrola Radio, the pouring forth of hundreds of thousands of salable units when the starting gun booms will not be enough. The radio receivers, automatic record changers and other fine-featured products from our plants must blend service and beauty . . . express ingenuity even in details such as engineered packaging for safer transit . . . all to serve America's foremost merchants.

The distinguished Detrola record changer, better than ever, will be made for selected radio manufacturers and jobbers.

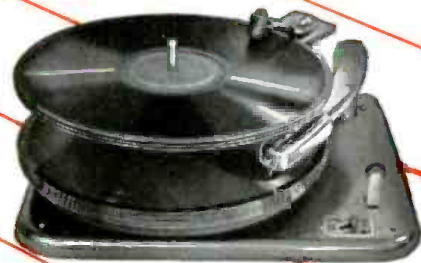

DIVISION OF INTERNATIONAL DETROLA CORPORATION • Detroit 9, Michigan

Detrola Radio

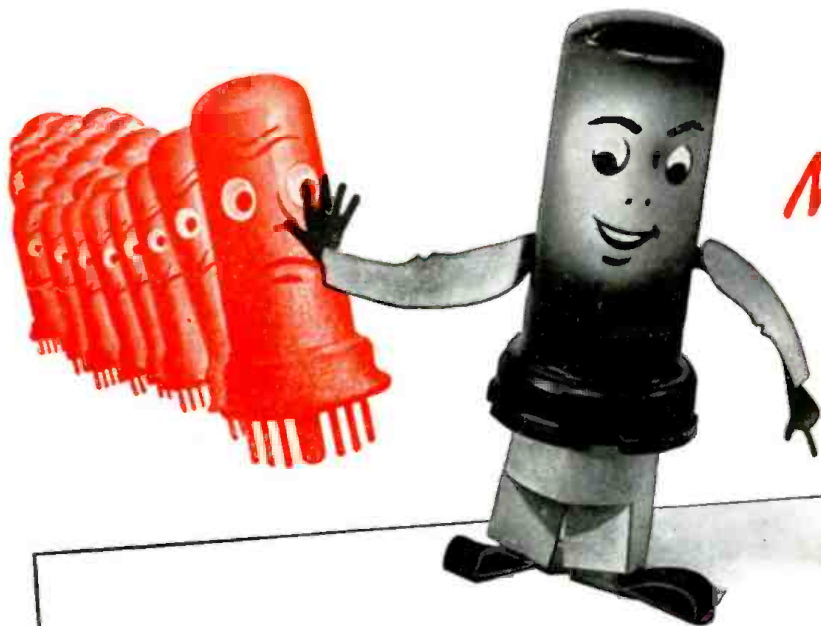

NOW- REPLACE OVER 875
TYPES OF BALLAST TUBES WITH
ONLY 10 N.U. UNIBALLASTS

N.U. UNIBALLAST

COVERS YOUR REPLACEMENT NEEDS WITH
ONLY 10 FAST-SELLING PROFITABLE TYPES

YOU BET Uniballast are a real profit-maker for service men. With only 10 types of N.U. Uniballast to carry, you keep your investment constantly turning, and putting profits in your pocket. Order Uniballasts today from your N.U. Jobber. And ask him for the "N.U. Uniballast Service Manual" or write—National Union Radio Corporation, Newark 2, New Jersey.

SPECIFICATIONS

- Uniballast—the universal ballast tube—small—compact—easy, quick installation.
- Metal envelope is excellent heat radiator. "Plug-in" simplicity.
- Provides proper operating current conditions regardless of variations in line voltage and in the characteristics of tube heaters and pilot lights.
- Even if one or more pilot lights burn out Uniballast continues to operate the tube filaments in the string, at efficient current range.
- Resistance is self-compensating—adjusts itself automatically—true ballast action. Voltage dropping range is indicated on every Uniballast.

NATIONAL UNION RADIO TUBES AND PARTS

*Transmitting, Cathode Ray, Receiving, Special Purpose Tubes • Condensers •
Volume Controls • Photo Electric Cells • Panel Lamps • Flashlight Bulbs*



Order Today from your N.U. Jobber

Actual size
Ov. Length 3 1/8"
Seated Ht. 2 1/16"
Diameter 1"

ADV Plans, LLC

Copyright Notice:

The entire contents of this CD/DVD are copyright 2014 by ADV Plans, LLC. All Rights Reserved.

Reproduction or distribution of this disk, either free or for a fee is strictly prohibited. We actively monitor and remove listings on eBay thru Vero.

You are free to copy or use individual images in your own projects, magazines, brochures or other school projects.

Only the sellers listed here are authorized distributors of this collection:
www.theclassicarchives.com/authorizedsuppliers

Please view our other products at
www.theclassicarchives.com,
or our ebay stores:

[TheClassicArchives](#)
[ADVPlans](#)
[SuperShedPlans](#)

